



SMART NETS

IST-2000-28090

Signal Management in Real Time

for

urban traffic NETWORKS

Deliverable 21

Comparative Evaluation Results and Cost Benefit Analysis

Report Version: version 2 - submitted
Report Preparation Date: March 2004
Classification: Public
Contract Start Date: June 2001 Duration: 34 months
Project Co-ordinator: Napier University (TRI)

Partners: Napier University, Technical University of Crete, Municipality of Chania, Siemens Greece, Southampton City Council, Siemens Traffic Controls (UK), University of Southampton, Kreisverwaltungsreferat München, GEVAS Software GmbH, TRANSVER GmbH



**Project funded by the European Community
under the “Information Society Technology”
Programme (1998-2002)**

DELIVERABLES SUMMARY SHEET

Project Number: IST-2000-28090
Project Acronym: SMART NETS
Title: Signal MAnagement in Real Time for urban traffic NETworkS

Deliverable N°: 21
Due date: March 2004
Delivery Date: March 2004

Short Description:

This deliverable provides a synthesis of the results of the evaluation of the TUC strategy in the three SMART NETS test sites (in Chania, Southampton and Munich), in terms of the effects on traffic flow and on fuel consumption and air pollution. It also presents the results of the cost-benefit analysis of the TUC strategy across the three sites. It further details the cross-site comparative evaluation of the operational aspects of the TUC strategy, drawing conclusions on the effect of individual site characteristics on the performance of the TUC strategy, with recommendations for future installations.

Partners owning: All
Main author(s): Helen Condie, Christiane Bielefeldt (TRi)

Co-Author(s): Elias Kosmatopoulos (TUCrete)
Andy Richards & Mike McDonald (TRG)
Jürgen Mück & Andreas Hanitzsch (Transver)

Made available to: Version 1: Peer reviewers
Version 2: CEC, all partners, public



Table of Contents

Executive Summary	v
1 Introduction	1
1.1 Objectives of the SMART NETS Project.....	1
1.2 SMART NETS Assessment/Evaluation.....	3
1.3 Structure of this Report	4
2 The Test Sites	6
2.1 Chania Test Site.....	6
2.2 Southampton Test Site.....	8
2.3 Munich Test Site.....	12
3 Impact Assessment	16
3.1 Introduction	16
3.2 Reduction of Traffic Congestion: UTC data	16
3.2.1 Weekdays	16
3.2.2 Saturdays	27
3.3 Reduction of Traffic Congestion: Floating Car Measurements	31
3.4 Fuel Consumption	44
3.5 Emissions	47
4 Comparative Evaluation of User Acceptance	50
4.1 Introduction	50
4.2 Results of User Acceptance Questionnaires	50
4.2.1 Data Requirements	50
4.2.2 Requirements for data transmission	52
4.2.3 Requirements for local controllers	53
4.2.4 Requirements of central data processing	53
4.2.5 Interoperability with existing systems	54
4.2.6 Ease of implementation.....	55
4.2.7 Ease of use of TUC system	56
4.2.8 Need for readjustment of parameters	56
4.2.9 Ease of adding or removing intersections to/from network	57
4.2.10 Conclusion.....	58
5 Socio-Economic Assessment	60
5.1 Introduction	60
5.2 Results of Socio-Economic Assessment	60
5.2.1 Costs for Implementation, Operation and Maintenance	60
5.2.2 Time Savings	64
5.2.3 Vehicle Operating Costs	69
6 Conclusions	72
6.1 Background.....	72
6.2 Results	72
6.3 Lessons Learnt from the SMART NETS Demonstrations	81
6.4 Recommendations for Future TUC Implementation.....	82
7 References.....	83



List of Figures

Figure 2.1 The urban network of Chania 6

Figure 2.2 Schematic map of Chania. 7

Figure 2.3 SMART NETS Trial Areas in Southampton 9

Figure 2.4 SMART NETS Trial Area in Munich..... 12

Figure 2.5 Signalised Junctions in the Munich Trial Area 13

Figure 3.1 Effect of masking on measured detector flows 17

Figure 3.2 Average Mean Speed difference (%) per hour for the whole of the final demonstration phase (Chania City Centre)..... 19

Figure 3.3 TUC (red curve) vs TASS (blue curve) for Mean Speeds in Chania City Centre in the final demonstration phase 19

Figure 3.4 Average Mean Speed per hour for weeks 1 and 2 of final demonstration phase (Chania Region 2)..... 20

Figure 3.5 Average Mean Speed per hour for weeks 3 and 4 of final demonstration phase (Chania Region 2)..... 20

Figure 3.6 Differences between Tailback and Occupancy Values during the a.m. Peak Hour (Munich) 24

Figure 3.7 Comparison of SCOOT vs TUC – Speed Differences in Southampton City Centre, Saturday 28

Figure 3.8 Comparison of SCOOT vs TUC – Speeds and Journey Times in Southampton City Centre, Saturday 30

Figure 3.9 Comparison of SCOOT vs TUC – Speeds and Flows in Southampton City Centre, Saturday 31

Figure 3.10 Map of Floating Car Route in Chania 32

Figure 3.11 Average Travel Time Difference (%) for Floating Car Measurements (Chania Region 1) 33

Figure 3.12 Average Travel Time Difference (%) for Floating Car Measurements (Chania Region 1, Heavy Links)..... 33

Figure 3.13 Average Travel Time Difference (%) for Floating Car Measurements (Chania Region 2) 34

Figure 3.14 Floating Car Route Southampton Bitterne Main Route..... 34

Figure 3.15 Floating Car Route Southampton Bitterne Side Roads..... 35

Figure 3.16 Floating Car Route Southampton City Centre 35

Figure 3.17 Average Journey Times on Bitterne Route during Weekday a.m. peak 36

Figure 3.18 Average Journey Times (Factored by Flow) on Bitterne Route during Weekday a.m. peak..... 37

Figure 3.19 Average Journey Times on Bitterne Route during Weekday off-peak 37

Figure 3.20 Demonstration Phase 2: Average Journey Times on Bitterne Route during Weekday p.m. peak 38

Figure 3.21 Average Journey Times on Bitterne Side Roads Route during Weekday a.m. Peak 39



Figure 3.22	Average Journey Times on Bitterne Side Roads Route during Weekday p.m. peak.....	39
Figure 3.23	Average Journey Times on Southampton City Centre Route during Weekday a.m. Peak	40
Figure 3.24	Average Journey Times on Southampton City Centre Route during Weekday p.m. Peak	41
Figure 3.25	Floating Car Route Munich.....	41
Figure 3.26	Average FCD Journey Times for Cars Starting at 07:00 and 08:30 (Munich).....	42
Figure 3.27	Averaged Travel Time Values for each Route and Start Time (Munich)	43
Figure 3.28	Average Fuel Consumption Difference (%) per Hour (Chania Region 1)	45
Figure 3.29	Average Fuel Consumption Difference (%) per Hour (Chania Region 2)	45

List of Tables

Table 3.1	Average flows and occupancies and t-test results for the final demonstration phase (Chania City Centre)	18
Table 3.2	Average flows and occupancies and t-test results for the final demonstration phase (Chania Region 2)	20
Table 3.3	Comparison of Southampton Bitterne Regional Results.....	21
Table 3.4	Comparison of Southampton City Centre Regional Results.....	22
Table 3.5	Number of Detectors with Significantly Different Results for SCOOT vs TUC Scenarios (Southampton).....	23
Table 3.6	Summarized Occupancy and Tailback Values (Munich)	25
Table 3.7	Summarized Speed and Travel Time Values (Munich)	26
Table 3.8	Summarised Speed and Travel Time Values (Munich, 4-week-values).....	27
Table 3.9	Harmonic speeds (Munich)	27
Table 3.10	Average Southampton City Centre Flows during Saturdays	29
Table 3.11	Average Southampton City Centre Speeds during Saturdays	30
Table 3.12	FCD Travel Times Aggregated by Routes (Munich)	43
Table 3.13	Summarized Travel Time Values for FCD Data (Munich).....	44
Table 3.14	Comparison of Fuel Consumption in Southampton.....	46
Table 3.15	Summary for Fuel Consumption in Munich.....	46
Table 3.16	Comparison of Emissions in Chania	48
Table 3.17	Comparison of Emissions in Southampton Bitterne	48
Table 3.18	Comparison of Emissions in Southampton City Centre.....	48
Table 3.19	Comparison of Emissions in Munich.....	49
Table 5.1	Comparison of Overall Costs	63
Table 5.2	Time Savings based on Measured Journey Times in Chania.....	65
Table 5.3	Time Savings based on UTC Speeds in Chania	65
Table 5.4	Time Savings based on Measured Journey Times in Southampton.....	66



Table 5.5	Time Savings based on Measured Journey Times in Southampton (factored by flow)	67
Table 5.6	Time Savings based on UTC Speeds in Southampton.....	67
Table 5.7	Time Savings based on Measured Journey Times in Munich.....	68
Table 5.8	Time Savings for FCD Routes Based on UTC Speeds in Munich.....	68
Table 5.9	Time Savings based on UTC Speeds in Munich.....	69
Table 5.10	Vehicle Operating Costs Chania	70
Table 5.11	Vehicle Operating Costs Southampton	70
Table 5.12	Vehicle Operating Costs Munich.....	71



Executive Summary

It was the objective of the SMART NETS project to further develop, demonstrate and evaluate the new-generation, network-wide signal control strategy TUC (Traffic-responsive Urban Control). Up to the start of SMART NETS, TUC had only been applied in a couple of small installations and investigated in extensive simulation studies. Both the small installations and the simulation results had shown that TUC certainly had the potential to bring about significant improvements in traffic flows and journey times compared with fixed-time control.

In SMART NETS TUC was installed in major network parts of Chania, Southampton and Munich and its performance was compared with the three resident systems TASS, SCOOT and BALANCE respectively. TASS had been installed in Chania quite recently, and a great deal of effort had gone into optimising and fine-tuning it; therefore TASS in Chania was already a much more challenging competitor to TUC than the fixed-time systems it had been compared against so far in real life and simulation. In Southampton, TUC was compared against SCOOT, the world-wide market leader in real-time signal control, developed more than 20 years ago and having undergone a series of amendments and improvements during this period. Moreover, the SCOOT application in Southampton has been extensively fine-tuned over the last 20 years and has to be counted as one of the best-maintained implementations anywhere. In Munich, TUC was compared to a brand-new installation of BALANCE, where both systems had equally little opportunity for fine-tuning; this could have been the fairest comparison between two relatively new and sophisticated systems had it not, unfortunately, been for the lack of data that was admissible for the evaluation.

The TUC implementation and operation was straightforward in all three sites even though they all had very different network and traffic characteristics and, furthermore, very different basic infrastructure. The latter is particularly relevant with regard to the detector types and locations: in Munich, detectors are typically only 30m from the stop-line and in Chania in the middle of the link; in Southampton they are near the entrance of the link and, furthermore, in many locations one single loop straddles two lanes.

All main conclusions are drawn from the second demonstration phase, since in any long-term application more time would have been devoted to fine-tuning than had been available, and at that time thought necessary, before the first demonstration phase. With hindsight, it became clear that further improvements could have been achieved for the TUC performance with further fine-tuning. However, there is no indication how significant these additional improvements might have been and, therefore, judgement for the purposes of this report has to be based on the evidence from the second demonstration phase in each site.

Impact Assessment

The principal aim of the TUC implementations in the three sites was to reduce traffic congestion. Therefore, this is the principal indicator used in the evaluation. Data for this assessment came from two main sources: UTC system data and floating car measurements.



Traffic Flows

From the UTC system, data concerning traffic volumes has been collected for two reasons: first of all, to ensure that comparisons between the performance of the different systems are being made for comparable traffic conditions and, furthermore, to find out whether any of the systems would increase the network capacity. If one of the systems had achieved any significant impact on the capacity in the controlled network, it would have been expected that there were differences between traffic flows in the surrounding network, in particular in the entry links. However, this was generally not the case, and the only links where substantially larger queues appeared under one system were located in Bitterne (Southampton), where SCOOT applies deliberate “gating” at some key entries in order to ensure sufficient capacity within the network. As it turned out, the gating was certainly harsher than necessary because under TUC, where traffic on these links was allowed to enter the network more or less freely, there was never oversaturation within the network. This meant furthermore that the traffic conditions for which TUC would have been expected to be particularly effective, namely oversaturation within the network where TUC could have potentially prevented blocking back into junctions and subsequent gridlock, never actually occurred in any of the three sites at any time under any of the four control systems.

Average network flows turned out to be in general apparently on a similar level under TUC and the resident systems unless there were obvious reasons for differences, such as special events or severe weather conditions. It was found, however, that problems with “masking” had more impact on the accuracy of the detector data than anticipated, which meant that the results derived from the detector data must be viewed with some caution.

Occupancy, Tailback, Speeds and Travel Times

The results derived from loop-detector measurements for the final demonstration phase clearly indicate that TUC outperforms TASS in the Chania City Centre Region for most time intervals by up to 13% in terms of mean speeds. The evaluation of the two systems through floating car measurements showed a clearly better performance of TUC compared with TASS, especially during peak hours, in the City Centre. Floating car trips performed when TUC was running had average travel times that were 5%-25% lower than those of TASS during peak hours. For the East Entrance Region, neither system outperformed the other.

The most successful evaluation results for TUC in Southampton were those obtained from data collected in the Bitterne region during the a.m. peak. The UTC data was comparable with that collected during SCOOT control and sometimes better, in particular where SCOOT applied gating. By averaging all individual detector values it was found that, at the same level of flows under both systems, the average ALOTPV (Average Loop Occupancy Per Vehicle) across the Bitterne region was approximately equal under SCOOT and TUC, although the speed decreased by about 4% under TUC in average for weekdays with simple flow factoring. Harmonic speeds indicated very significant advantages for TUC of up to 18% for the a.m. peak as well as for the overall weekday. The FCD (Floating Car Data) results for the a.m. peak showed journey time reductions on the main arterial survey route by an impressive 30% under TUC or still 8% after factoring each route section journey time by the flow, with the most substantial improvements again on the gated links. FCD surveys were also undertaken along a very convoluted route, focusing on the side-roads rather than the main corridor, and there the overall route journey time increased by about 10% under



TUC in the a.m. peak, or 15% after factoring by flow. During the off-peak and p.m. peak, the journey time along the Bitterne main corridor route showed under TUC about 5% benefits compared to SCOOT. Again, some of this benefit was 'lost' to SCOOT on the side-road survey route, but the benefits to the main arterial route still outweighed the disbenefits experienced in the side road traffic in all time intervals.

For Southampton City Centre, ALOTPV was reduced by about 25% under SCOOT in the a.m. peak compared to TUC, although this result may have been amplified by the suspected underestimation of TUC flows. Although TUC performed better during the p.m. peak compared to the a.m. peak, generally the results still did not quite match those of SCOOT. The global results show that the average speeds under SCOOT were about 4% (mean speed) and 1% (harmonic speed) higher than under TUC, while ALOTPV reduced by about 15%. Based on FCD results, the a.m. peak journey time on the City Centre survey route increased by about 10% under TUC compared to SCOOT, and during the p.m. peak even by about 20%, which meant that the picture for TUC was worse than shown by UTC speeds for both time periods. This was one exception to the general pattern that had emerged, where TUC fared better in the FCD measurements than when judged by UTC data.

For Southampton, data collected on Saturdays had been evaluated separately from that of weekdays. Unfortunately the quantity of data collected during the second demonstration phase on Saturdays was very limited. Furthermore, the first two Saturdays had fine weather whereas on the two other Saturdays it was raining. In addition, on one Saturday when TUC was being implemented, the Rugby World Cup Final was televised and this clearly resulted in lower flows from 09:00 to 11:30. However, a detailed analysis of the available data did show that there was very little difference between the performance of TUC and SCOOT in Bitterne and on the two dry Saturdays in the City Centre. Moreover, on the Rugby World Cup day traffic volumes increased dramatically once the match was finished and TUC coped remarkably well with the sudden surge of traffic, keeping traffic speeds and floating car journey time at the same level as on the previous dry weather morning. Even in the following hour, when TUC had to cope with 530 veh/h, the speed still stayed at nearly 27 km/h, while under SCOOT the speed already dropped to the same level of speed at the 26% lower flow of 420 veh/h on the following Saturday.

In Munich there were significant problems with both the lack of data and its high variability, for FCD data and for flow and occupancy measurements, and even more so for model-based tailback and speed calculations. This means that all of the Munich results, and in particular those based on tailback and speed, need to be viewed with some degree of caution.

From the data that is available for Munich, it appears that average flows have been around 2% higher under TUC (3% during the peak periods) over all four weeks. The summarised values for occupancy are very similar and, given that flows and occupancy are closely correlated, indicate that both systems performed on more or less the same level. Estimated tailbacks as well as speeds and travel times, which are derived from tailbacks, show a slight advantage for BALANCE for the whole weekday (with a larger advantage during peak hours) but an advantage for TUC during the off-peak. The data that is available from the floating car measurements shows on average 6.3% and 2% lower journey times under TUC for Routes 2 and 3 respectively. For Route 1, which is the main route leading into the city, a.m. peak journey times are on average 15 % lower for TUC than for BALANCE.



Fuel Consumption and Emissions

Increases or decreases in fuel consumption followed the same direction as emissions in all sites and for all time periods. With the one exception of the Southampton Saturday data (where both indicators were much lower under TUC), differences between the resident UTC systems and TUC were very small, generally less than 3%. Furthermore, both indicators were roughly in line with the findings for mean and harmonic speeds, as could be reasonably expected, given that speeds are the variable used for calculating them. One exception was the Southampton City Centre, where fuel consumption and emissions were lower for TUC, although the mean speeds were higher, but no explanation could be found for this phenomenon.

Impact on Public Transport

Although a module for public transport (PT) prioritisation was especially developed for TUC in the SMART NETS project, public transport travel times were not a primary consideration in the evaluation process. In the case of Chania they were not investigated separately, since there are no bus priority measures in place and buses would benefit from reduced congestion in the same way as cars. In Munich, neither TUC nor BALANCE influence public transport, since buses and trams are given priority here by local controllers that are allowed to override control decision made by the central system. Neither BALANCE nor TUC were in any way an impediment to this, and therefore neither control system led to any increases in PT travel times in Munich. In Southampton, bus travel times had been observed during the verification phase, and it was concluded that TUC's bus priority was generally working appropriately.

User Acceptance and System Costs

Overall, user acceptance of TUC was very high, and especially so in Chania. The operators reported that TUC is an excellent strategy that, with careful fine-tuning, can show a very efficient performance.

According to the responses to the User Acceptance Questionnaire the implementation of TUC was very straightforward in all sites, but again this was felt particularly in Chania when compared with the effort required for a TASS implementation. The main effort involved for implementing TUC in all sites was the development of the new interface between TUC and the existing system. The one additional data requirement for TUC is the need for estimates of turning movements and the Southampton operators did carry out special surveys to get accurate data, which incurred additional costs. TUC's requirements for local controllers are lower than for TASS and the same as for BALANCE and SCOOT while, with current computer technology, there are no differences in necessary costs for any of the four systems. Requirements for data transmission are approximately equal for TUC, TASS and BALANCE, while SCOOT requires second-by-second data interchange, which can significantly increase transmission costs, depending on the communication infrastructure.

The most significant disadvantage for TUC was the current lack of a good user interface, which was strongly missed by the Southampton operators. It is clear that for the future commercial exploitation of TUC such an interface will need to be built.



The costs involved in operating TUC are very much the same as for the other systems, except for the above-mentioned potential cost difference for data transmission. System maintenance costs for TUC are expected to be the same as for BALANCE, somewhat higher than for SCOOT (since the Southampton believe it easier to make adjustments to SCOOT) and lower than for TASS due to a lesser need for parameter updates.

Overall, all operators felt that TUC had performed remarkably well compared with much more established systems, even if not all hopes concerning TUC's potential to reduce congestion could be fulfilled. The city authorities in Southampton and Munich (SCC and KVR) would have supported further TUC implementations in their cities if the impact assessment had provided clear evidence that TUC could improve significantly on SCOOT and BALANCE. In the current circumstances, SCC and KVR will watch any further development of TUC and results of future TUC implementations in order to decide whether TUC should be installed in other parts of their cities at a later stage. In contrast to SCC and KVR, the Chania operators were already convinced by TUC's current performance, and they have every intention to use and exploit TUC beyond the lifetime of SMART NETS.

Socio-Economic Benefits

The highest benefits were generally calculated from time savings based on floating car data, but some of the UTC data also leads, summed up over the whole year, to very high benefits.

The best overall result was achieved for Chania City Centre, where even the more conservative estimate based on UTC data leads to time savings worth a staggering €0.6m per year. It seems therefore safe to say that the annual total benefits from TUC in Chania will far outweigh any possible investment, operation and maintenance costs in a UTC system in a short time period, even if TUC had been implemented from scratch and not been introduced as an alternative to the existing TASS system.

For Southampton the results are less conclusive and vary largely depending on the data used for the benefit calculation. For the City Centre, floating car data is only available for peak hours but the total time savings under SCOOT for four peak hours, based on this data, add up to €1.1m per year if taken as measured, or a still a very substantial €0.7m if the journey times are factored by flow. UTC based harmonic speeds, which are available for the whole day and are therefore in this case much more representative than FCD-based results, lead to a lower but still significant figure of €0.09m per year.

For Bitterne, there are also time savings under SCOOT for the Side Roads Route, which amount to €0.8m per year as measured, and €0.3m if factored by flow; but this again is data for peak hours only. All other data in Bitterne shows major advantages for TUC. The (peak hour only) data for the Bitterne Main Route indicates savings of €1.0, or €0.3m if factored; in both cases this would outweigh the anyhow less representative results for the Side Roads Route. If the off-peak measurements are included as well, the benefits for the 12-hour day amount to €1.4, respectively €0.7m per year. And even the more conservative figures based on harmonic speeds from the UTC system still lead to a net benefit of €0.3m per year for TUC.

In Munich, the FCD data would indicate an annual benefit through time savings for the a.m. peak alone of up to €0.3m under TUC, while the UTC data would indicate savings of



anywhere between €0.08m per year under TUC and €0.2m per year under BALANCE for the whole 11-hour day, depending on the demonstration weeks used for the calculations.

Savings from Vehicle Operating Costs are, as is completely normal, only in the range of 10% of the benefits from time savings for all demonstration sites.

Overall Conclusions

TUC performance in all of the test sites has demonstrated that it is a valid and credible UTC strategy both as a stand-alone system, as in Chania and Southampton, and as a hybrid system. Since two very different versions of such hybrids had been used within SMART NETS - one in conjunction with BALANCE in Munich and one, during the first demonstration phase, with SCOOT in Southampton - it appears credible that combinations with any other UTC system would be possible as well.

Although the demonstrations did not show the same level of improvements as had been achieved by TUC in simulations compared with simple fixed-time control, TUC stood up very well against the well-established and sophisticated resident systems in the three cities.

The improvement in the results from the first to the second demonstration phases in Southampton and Chania showed that, initially, the potential for optimising TUC's performance through fine-tuning had been underestimated and it has become apparent that TUC performance could still have been improved, mainly by further tuning of weights and importance factors given to individual links. In Southampton further improvements would probably have been possible by splitting the two large control areas into sub-areas, allowing different cycle times to be applied between them, as is currently done by SCOOT and has also been proven successful for TUC in the Chania application.

Problems with detectors have been encountered in all three sites and, moreover, problems with the basic control and communication infrastructure have persisted in Munich throughout the demonstration. The results of all the demonstrations have shown convincingly that TUC is a very robust system that could provide satisfactory signal control even under these adverse conditions.

One further very important finding from the demonstrations is that TUC can perform well in any type of network: the five test areas in the three cities have very different characteristics, both with regard to network layout and with regard to traffic behaviour. This allows the conclusion that TUC could be successfully implemented in any other site in Europe or elsewhere in the future.

Overall, the SMART NETS project has demonstrated that TUC has the potential to become a strong competitor in the worldwide UTC systems market.



1 Introduction

1.1 Objectives of the SMART NETS Project

The SMART NETS project falls within Key Action I (KA1) of the Fifth Framework Programme “Systems and Services for the Citizen”. For this key action, the programme states that “the emphasis has to be put on innovative systems that can demonstrate clear progress compared to the state of the art in particular in respect of user-friendliness, cost effectiveness and quality of service”. The aim of SMART NETS was to demonstrate that the new-generation control strategy TUC (Traffic-responsive Urban Control) can reduce urban congestion, while requiring less dedicated infrastructure than most comparable systems and being easy to implement and run by the urban signal control operator.

More specifically, SMART NETS addresses action line I.5 “Transport and Tourism”, and within this line IST 2000 – I.5.1 “Intelligent transport infrastructures”, which focuses on three lines of development, one of which is “intelligent integrated urban and interurban traffic management systems, including co-ordinated motorway control, management of large-scale events and crises, management of over-saturated networks and network disruptions, including advanced modelling and simulation”. SMART NETS provides a subset of this development by demonstrating an intelligent urban traffic management system for the management of over-saturated networks. Advanced modelling and simulation was used as a tool to prepare this demonstration.

Many years of research and development worldwide in the area of real-time (traffic-responsive) urban traffic control has resulted in a number of control strategies that employ different design philosophies and have various, partially common and partially distinct, characteristics. Overall, the achievable or demonstrated improvements in average journey times (to name just one performance criterion) range from 0 to 20%, but are found to strongly degrade under saturated traffic conditions that may in some cases lead to fatal gridlock in the network. All available urban traffic control strategies suffer from three major disadvantages:

- They base their signal control decisions for individual junctions on local real-time measurements only.
- Most strategies have rather strict requirements regarding real-time measurements and complex implementation codes, which are both obstacles to interoperability and increase the installation and maintenance costs.
- They are not conceived for saturated traffic conditions, which are daily encountered in metropolitan areas around Europe and beyond. This leads to a waste of green times and, in some cases, to gridlock in the network, along with a corresponding degradation of network performance.

The design of the TUC urban traffic control strategy is based on the combination of two methodological principles:

- store-and-forward based modelling, to avoid the exponential complexity arising from the use of binary variables when addressing traffic light changes, and
- the linear-quadratic (LQ) control method to design an efficient but simple multivariable regulator.



The TUC control law calculates the splits of all stages of all junctions in the network at each cycle. Cycle lengths and offsets may either be left constant or modified by TUC in real-time.

TUC was initially developed as part of an integrated traffic control system for corridor networks within the European Telematics Applications in Transport project TABASCO (Telematics Applications in BAvaria, SCotland, and Others). The first version of TUC controlled only green splits; after the initial development and the first field implementation and evaluation, TUC was further expanded so as to perform cycle and offset control. Within the SMART NETS project, the cycle and offset extensions of TUC have been further investigated, while another expansion has been introduced to allow for public transport priority possibilities.

The TUC strategy consists of five component parts:

- The basic methodology employed for **split control** by TUC is the formulation of the urban traffic control problem as a Linear-Quadratic (LQ) optimal control problem based on a store-and-forward type of mathematical modelling. The control objective is to minimise the risk of oversaturation and queue spill-back and this is achieved through the appropriate manipulation of the green splits at signalised junctions for given cycle times and offsets.
- Longer cycle times typically increase the capacity of the junction as the proportion of the constant lost time becomes accordingly smaller. Longer cycle times may however increase vehicle delays at undersaturated junctions with longer waiting times during the red phase. The objective of **cycle control** is to increase the junctions' capacities as much as necessary to limit the maximum observed saturation level in the network. Within TUC, this objective is achieved through the application of a simple feedback-based algorithm that uses as criterion for the increase or decrease of the cycle, the current maximum saturation level of a pre-specified percentage of the network links.
- **Offset control** is achieved through the application of a decentralised feedback control law that modifies the offsets of the main stages of successive junctions along arterials so as to create when possible "green waves", taking into account the possible existence of vehicle queues. To implement a new offset in TUC, a transient cycle time is temporarily implemented at all but the first junctions along an arterial. The transient cycle time is implemented one single time, after which all the junctions along the arterial are co-ordinated according to the new offset.
- TUC provides **public transport priority** through implementation of an additional TUC module. The aim of this module is to provide direct priority to public transport vehicles by locally modifying the network-wide signal settings produced by the other parts of TUC. The priority approach followed by TUC is characterised as active or real-time, reactive, rule-based and can be conditional or unconditional.
- A dedicated **data processing** part of TUC is responsible for the collection and processing of the real-time measurements collected from the controlled network so as to prepare the input data set required by the split, cycle and offset control and public transport priority parts of the TUC strategy.



SMART NETS Deliverable 9, the Final System Development Report, describes in detail the components of TUC that are introduced above, and the functional architecture of each TUC module.

In simulation tests TUC has led to improvements in the order of 40% of journey times as compared to fixed-time settings under saturated traffic conditions. The TUC demonstration has been conducted in extended network parts of Southampton, Munich and Chania, including field-comparisons with the current resident control methods in those cities (SCOOT, BALANCE, TASS). In this way, in SMART NETS the performance of TUC has been evaluated against three base cases of more sophisticated and adaptive traffic control.

There have been three key stages in SMART NETS. The first stage in the project was the design and testing of TUC for the three sites and the inclusion of public transport priority in TUC. At this stage extensive simulation investigations were performed, using the validated macroscopic simulator METACOR, under different scenarios of demand, incidents, device failures, etc., and based on various criteria (such as average journey time, throughput, saturation levels, fuel consumption). The outcome of this stage was the design of the control law and the preliminary assessment of TUC's capabilities for the three application networks.

This was followed by the field implementation and verification of the strategy in the three test sites. The same generic software was implemented in all sites, while the particular topologies and traffic conditions were reflected in corresponding individual input files for each network application. The outcome of this stage was the TUC implementation in the three sites and a demonstration of its transferability and easy applicability.

Finally, there were field demonstrations, allowing assessment of the strategy through field-comparison with the existing control methods in each site and a comparative evaluation of the operation of TUC across all sites. The results of this evaluation are reported deliverables D18, D19 and D20 for Chania, Southampton and Munich respectively.

1.2 SMART NETS Assessment/Evaluation

The assessment of the performance of TUC in Chania, and in Southampton and Munich has been carried out in accordance with the framework and methodology described in SMART NETS Deliverable 13, the Final Evaluation Plan. D13 is based on the guidelines and framework developed in the CONVERGE project in FP4. The CONVERGE guidelines give seven key stages in the Evaluation process, which have been followed in the evaluation of the TUC strategy in the SMART NETS project. These are:

- definition of user needs;
- describing applications;
- defining assessment objectives;
- pre-assessment of expected impacts;
- assessment methods;
- data analysis;
- reporting results.



The definition of assessment methodology in D13 followed the steps outlined by CONVERGE.

The key steps were:

- Definition of the **reference case**, that is the base case against which the newly-installed TUC system is to be assessed.
- The **definition of indicators**, that is the measurable indicators for the “before” and “after” TUC cases, that will allow assessment of TUC performance.
- Plans for data collection, including:
 - types of data to be collected (**data categories**)
 - timetable of data collection (**measurement plan**)
 - sample sizes required for analysis (**statistical considerations**)

The SMART NETS Evaluation Results deliverables contain the evaluation results from the demonstration of the TUC system, developed in SMART NETS, in each test site. The Evaluation Results deliverables describe in detail the results of the impact assessment of TUC, covering:

- its impact on traffic congestion through reduced travel times, increased traffic speeds and increased throughput of traffic
- environmental impact of TUC, reduced fuel consumption and emissions
- assessment of User Acceptance
- socio-economic assessment

In this way the same evaluation framework has been used in each site, and the same format for reporting evaluation results has been followed. There exists from each of the three sites compatible sets of data for impact analysis and cost-benefit analysis. This allows a comparative evaluation of the results of the TUC demonstrations across all sites. Comparative evaluation allows insights into the influence of site-specific network and traffic characteristics on the overall performance of TUC and the resident systems.

1.3 Structure of this Report

Section 2 describes each of the SMART NETS test sites, the network topology, the demonstration scenarios implemented, the timing of demonstration and a summary of data collection.

Section 3 describes the comparative evaluation of impact assessment across the three sites, based on UTC data for speed, flow and occupancy, and on journey time data from floating car surveys. The assessment covers data from weekdays and from Saturdays. This chapter then describes the assessment of fuel consumption and emissions across the three sites, which has been modelled, based on the UTC data collected.

Section 4 describes the comparative evaluation of user acceptance across the three sites, based on the responses received from each site to the User Acceptance Questionnaire.



Section 5 describes the comparative socio-economic assessment of the impact of TUC across the three sites. Implementation, operation and maintenance costs are compared against journey time savings from the impact assessment.

Section 6 concludes the report and summarises the findings from the SMART NETS comparative evaluation.

2 The Test Sites

2.1 Chania Test Site

Chania is the second largest city in Crete. The Chania trial network is marked on Figure 2.1, and it has a total road length of approximately 8km and consists of 23 controlled junctions. Most of the links in the network have only one lane, which means that unexpected events (such as accidents) block the link and deteriorate traffic conditions, even if their duration is only a few minutes. Congestion problems are not limited in the streets with the unexpected events but are propagated to many other streets. Thus the control strategy should be able to deal with those problems. During the morning and evening hours there is a frequent bus service in almost every part of the network. Pedestrian movements are not a problem in the network and there is no reason for a special treatment. Public transport priority is not an issue in Chania, and it has therefore not been implemented in the field trial.

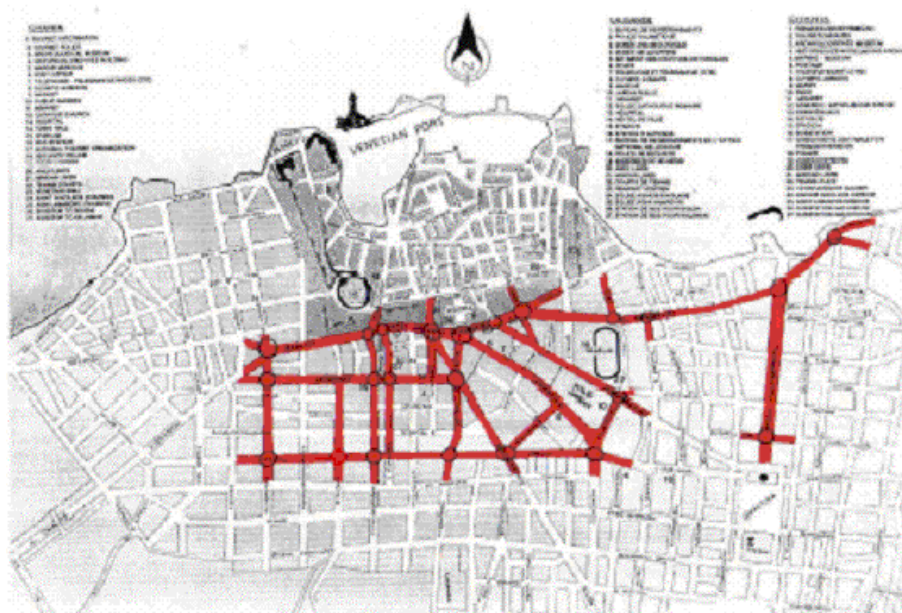

Figure 2.1 The urban network of Chania

The traffic junctions on which the TUC strategy has been applied are shown in Figure 2.2. Junctions with common signalling receive the same numbering, e.g., junctions 1a, 1b, 1c.

TUC Demonstration Scenarios

Two different UTC control systems (often referred to as control scenarios, or simply ‘scenarios’ in the remainder of this report) were tested at the Chania site. These two scenarios were:

1. TASS System – the cycle time, offset and green split of each signalised junction were generated and controlled by TASS. Since TASS was the existing UTC system in use, this scenario served as the base reference case.
2. TUC System – TUC was implemented in the Chania test site in one mode, TUC only. All the control modules of TUC were enabled. The split control module was

activated once per TUC-calculated cycle time, while the cycle and offset control modules were activated every 5 or 10 minutes. Offsets of junctions with common signalling (e.g., junctions 1a, 1b, 1c) are fixed.

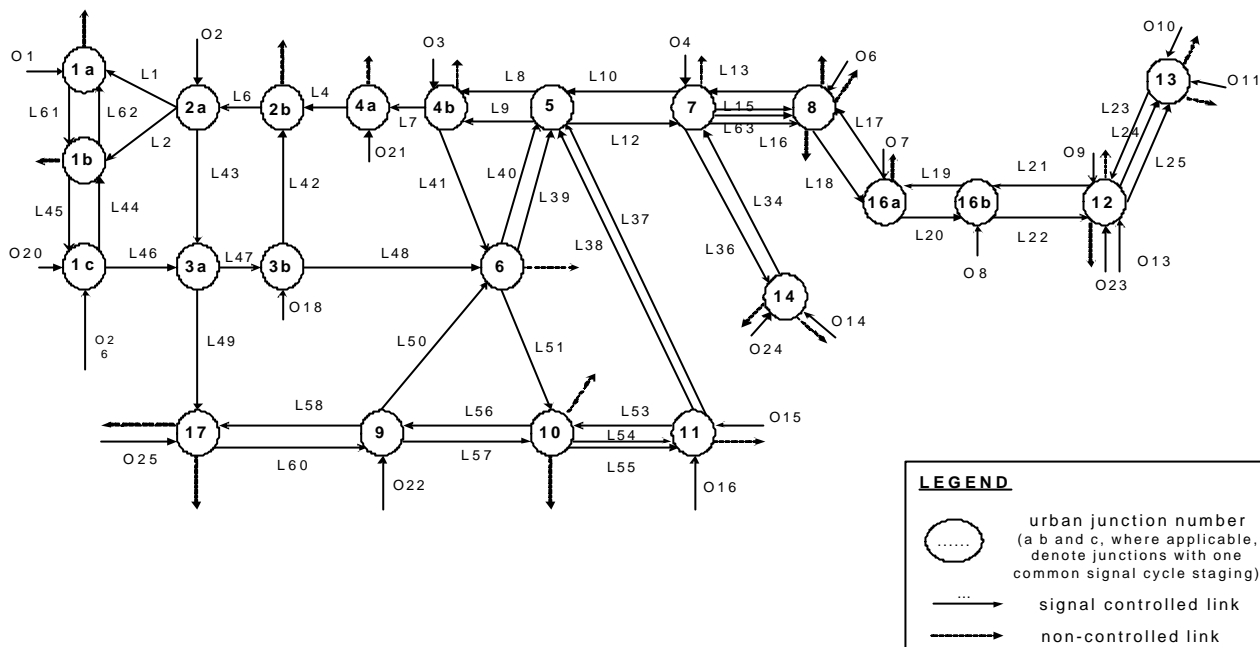

Figure 2.2 Schematic map of Chania.

First Demonstration Phase

The initial SMART NETS demonstration in Chania began on 19/05/03 and ended on 31/08/03. A total of 10 weeks of demonstration of the two systems was considered in the evaluation analysis for this phase. Each of the two UTC system scenarios was in operation for a total of four weeks during the first eight weeks. The use of each system was rotated on a weekly basis, and each system was in operation every day from about 07:00 to 03:00. During the last two weeks the alternation between the two systems was performed more frequently, but still ensuring an equal number of each of the days in the week for each scenario.

Second (Fine-Tuning) Phase

Following the first demonstration phase TUC was modified to address a number of issues that had arisen; these issues are discussed in detail in SMART NETS Deliverable 18, Evaluation Results Chania. During this phase, when all these modifications to TUC were being made, data collection continued. The fine-tuning phase started on 01/09/03 and finished on 02/11/03. All the weeks of demonstration of the two systems were considered in the evaluation analysis for this phase. As was the case in the final two weeks of the first demonstration phase, the alternation between the two systems was performed every three or four days, and ensuring an equal number of each week day for each scenario. Each system was in operation every day from about 07:00 to 03:00. During this phase the network was divided into two “regions” (to allow the application of different cycle times) – the main City



Centre region (Region 1) and the East Entrance region (Region 2), comprising the two junctions at the east of the network (see Figure 2.2).

Final Demonstration Phase

The final demonstration phase then began on 03/11/03 (a Monday) and ended on 29/11/03 (a Saturday). This four-week duration was split into two weeks of TASS (used to generate the base reference data) and two weeks of TUC. Each system was alternated on a weekly basis. The month of November was chosen for this second phase because it would provide (in theory) a four-week block of consistent traffic conditions. Only the results of this final demonstration phase are to be considered for the comparative evaluation.

Data Collection

System data was available throughout demonstration from the automatic data collection at the 24 strategic detectors installed in Chania as part of the TASS system. The data output by these detectors is the % occupancy of the detectors and the traffic flow. Furthermore, the new detectors installed for the operation of TUC provided traffic counts as well as the occupancy measurements needed for TUC. The measurement data was directly saved in the TUC PC of the traffic control centre (a PC that is used only for the purposes of TUC implementation). The measurement data that are used for evaluation are the data from 08:00 to 23:00 for every day of the final demonstration phase.

Floating cars were used for the collection of journey times. Floating car data collection was made manually with the use of timers. The measured travel times were reported within appropriately prepared data sheets. The travel times were measured from stop-line to stop-line (or passes of a traffic light, where the stop-lines are badly marked). This is a link travel time that includes any potential delays due to congestion and/or the signal control (e.g., red traffic light). A map of the route taken for the floating car measurements is included in chapter 3.3 as Figure 3.10.

The conditions under which the data were collected during the operation of the different scenarios were supposed to be, as far as possible, comparable in terms of demand and weather. To ensure that comparable conditions could be found to the largest possible extent, the scenarios were alternated weekly, where possible. For the final demonstration phase, the weather markedly deteriorated for one day, on one evening there was a protest in the city centre, and there were three weekdays that were local holidays. No major incidents were reported during any of the three phases, although there were some minor roadworks that had the same effect as – the very usual phenomenon of - vehicles double or illegally parked, and thus it was decided not to take special account of the effect of these minor roadworks. Further details of the demonstration phases in Chania can be found in D15, the Demonstration Report for Chania.

2.2 Southampton Test Site

Southampton, with a population of 216,000, is the largest city on the south coast of England. The use of Southampton as a SMART NETS demonstration site has enabled the performance of TUC to be directly compared with SCOOT. In Southampton the SCOOT system has been operating for approximately 20 years and has benefited from many

developments and enhancements since its initial installation. However, whilst SCOOT remains a highly effective means of real-time traffic signal control in free-flow conditions, it does have disadvantages in congested conditions. SCOOT is not designed to directly manage a fully saturated road network, i.e., a network where vehicle queues do not fully dissipate at the end of green and exit blocking at junctions is common. The TUC system, meanwhile, has been especially developed for use in congested conditions.

Two distinct sub-areas within Southampton were used for the SMART NETS demonstration: the City Centre and Bitterne, as shown in Figure 2.3. The remaining sub-areas in Southampton were controlled, as usual, by the SCOOT system during the SMART NETS demonstration. The prime objective of the project for Southampton was the implementation, demonstration and evaluation of TUC as an operating control system working within the city’s UTC system alongside SCOOT in congested periods.

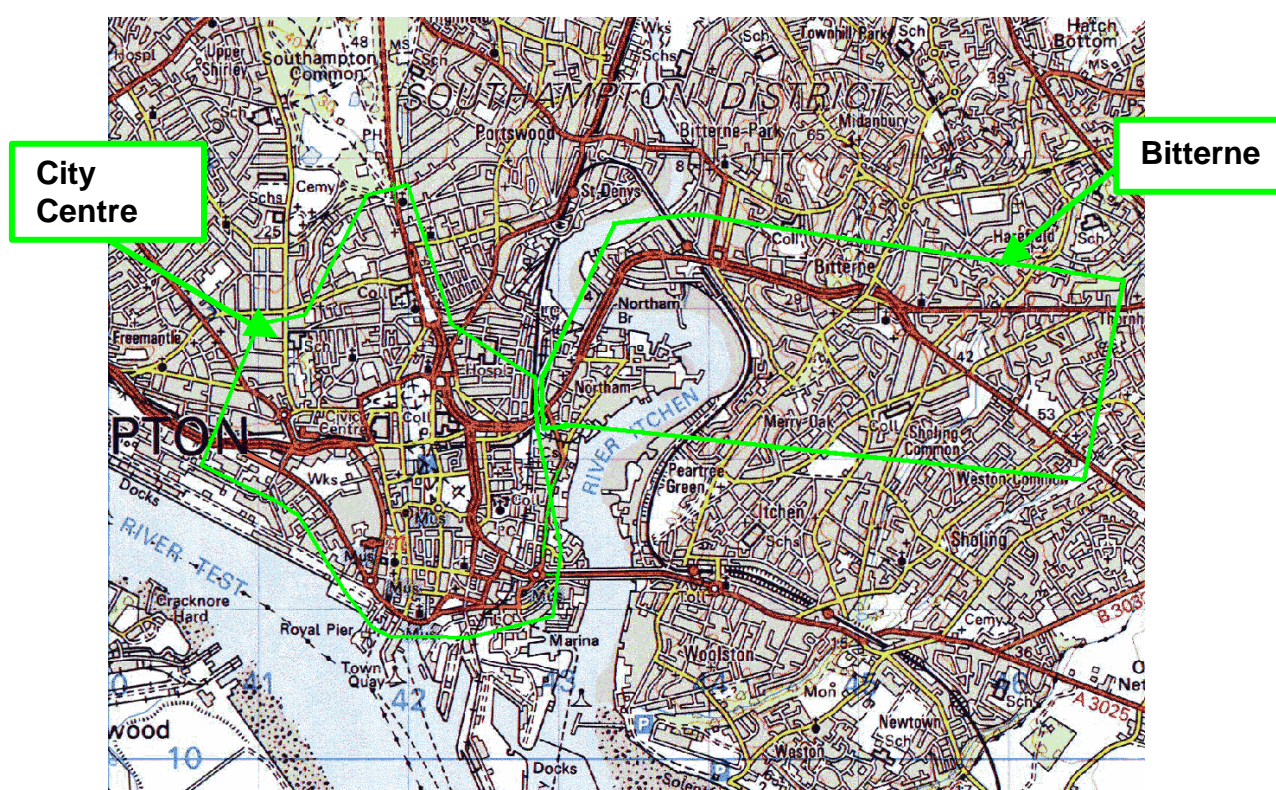

Figure 2.3 SMART NETS Trial Areas in Southampton

The City Centre trial area comprises 35 inner-urban signalised junctions, all UTC-controlled, and is typified by the short distance between each node. This City Centre network contains both the main shopping area and the commercial and business centre of Southampton. The main railway station and three port entrances are also contained within this trial area. All of these factors combine to cause high road traffic demand on a constrained and relatively cramped road network. In common with most cities, the City Centre road network in Southampton is usually congested in the morning and evening peak periods. In addition to this daily congestion, the City Centre is also subject to occasional congestion caused by special events such as Premiership football matches and the arrival and departure of large cruise ships.



Generally, congestion within the City Centre is at its worst on Saturdays and is located predominantly on the road network surrounding a large shopping complex (the West Quay shopping centre). The cause of this congestion, which on Saturdays typically extends from mid-morning to late afternoon, is the large volume of traffic arriving in a short space of time all destined for a relatively small number of car parks. This causes exit blocking throughout the local road network in the City Centre, a situation that is later exacerbated when traffic begins to leave the car parks whilst inbound traffic flows continue to remain high.

The second trial area in Southampton is Bitterne. The River Itchen separates the city centre from the extensive suburban areas to the east. The river can be crossed by one of five bridges, which are often severely congested at peak periods. This second sub-area includes the radial route (the Bitterne Corridor) accessing the city centre from Bitterne via Northam Bridge. On the arterial route, traffic is 'gated' (i.e., artificially held back by extended red times at the signalised junctions) at some entry points during the morning peak period to allow public transport priority and to ensure that the maximum capacity at the river crossing is not exceeded. The length of the Bitterne trial area is 3.5 km and it contains 18 signalised junctions.

TUC Demonstration Scenarios

Three different UTC control systems (or scenarios) were tested on the two SMART NETS regions at the Southampton site. These three scenarios were:

1. SCOOT System – the cycle time, offset, green split and public transport priority (where relevant) of each signalised junction were generated and controlled by SCOOT. Since SCOOT was the existing UTC System in use, this scenario served as the base reference case.
2. TUC System – the cycle time, offset and green split of each signalised junction were generated and controlled by TUC.
3. Hybrid System – this was a combination of the SCOOT and TUC systems. The cycle time and offset of each signalised junction were generated by the SCOOT system, but the green split was generated by the TUC system.

First Demonstration Phase

The initial SMART NETS demonstration in Southampton began on 07/04/03 (a Monday) and ended on 28/6/03 (a Saturday), a total of 12 weeks. Each of the three UTC system scenarios was in operation for a total of four weeks during the duration of the demonstration. The use of each system was rotated on a weekly basis, and each system was in operation every day (apart from Sundays and public holidays) from 07:00 to 19:00.

However, towards the end of the first demonstration, it became apparent that there were opportunities to modify the TUC software and, in addition, there were concerns about the reliability of several detectors in the Southampton test site, especially in the City Centre region. Therefore, the demonstration was put on hold during the summer while modifications were incorporated into the TUC software. In addition, all potentially faulty detectors in the SMART NETS test area were checked, although no faults were found.



Second Demonstration Phase

A second demonstration phase then began on 03/11/03 (a Monday) and ended on 29/11/03 (a Saturday). This four-week duration was split into two weeks of SCOOT (used to generate the base reference data) and two weeks of TUC. As before, each system was alternated on a weekly basis. Because of time and budget constraints, the hybrid system was not demonstrated during the second phase. November was chosen for this second demonstration phase because it would provide (in theory) a four-week block of consistent traffic conditions. An earlier date was excluded because the demonstration period would be interrupted by 'abnormal' events. The International Boat Show occurred in Southampton in late September and school half-term holidays were in late October. Only the data from this second demonstration phase is used for the comparative evaluation.

Data Collection

The main emphasis of the evaluation was on the impact assessment of the various UTC system scenarios, although this was supported by a user acceptance evaluation of TUC (based on a questionnaire interview survey completed by a control room operator) and a partial socio-economic assessment of the system (using modelling of fuel consumptions and emissions, based on data derived from the impact analysis). Two main methods of measurement were used within the impact assessment: UTC system data provided directly from the loop detectors, and; floating car data to measure journey times along pre-defined routes.

The UTC U07 message was used as the basis for the detector data. This message is output for all detectors within the Southampton network every 5 minutes and includes the parameters: flows, speeds and 'congestion' (or more specifically, Average Loop Occupancy Time Per Vehicle). A subset of 'relevant' detectors was chosen as the basis for the SMART NETS evaluation. This consisted of 99 detectors from the City Centre area and 53 from the Bitterne region. In addition, data was collected from 11 detectors located outside the SMART NETS regions with the objective of verifying that the effect of any system being demonstrated within the project was constrained to the SMART NETS test area.

Two Excel databases (one for each demonstration phase) were then developed to aggregate the U07 data into hourly intervals. For each detector, the average flow, speed and ALOTPV values were produced for every hour (07:00-19:00) within the demonstration period. Sundays and public holidays were excluded. It was important that the conditions under which the data was collected during the operation of the different control systems were, as far as possible, homogenous. Therefore, a data screening process was undertaken to exclude data directly affected by system faults, which could either affect the system globally (e.g., the UTC database was occasionally updated, which affected the collection of the U07 data) or individual detectors. A more subjective filtering of the data was also undertaken to exclude any detector data potentially affected by 'abnormal' events such as roadworks or incidents (using the operator log file as a basis). Detailed records of the weather conditions, system faults and incident logs can be found in D16, the Demonstration Report for Southampton.

Journey time surveys were undertaken using floating cars. The routes were chosen to represent a mixture of major/minor approaches to signalised junctions and a variety of

congestion levels. For each floating car survey, each driver was equipped with a stopwatch and dictaphone to record the time at which each checkpoint was passed. (A typical checkpoint corresponded to the stop-line at a signalised junction). After each survey, the data was extracted to an Excel file to produce the journey time along the overall route and the journey times between the checkpoints. As before, Sundays and public holidays were excluded and a data screening process was undertaken to exclude any data thought to be influenced by external events.

In the first demonstration phase, one route covered the Bitterne area and the other the City Centre. For the Bitterne route, the same surveyor and car were used at all times. The starting times of the surveys were 08:00, 12:00 and 17:00 on all weekdays (excluding public holidays). In the second demonstration phase, the Bitterne and City Centre routes remained unchanged. However, an additional survey route was devised for the Bitterne area, with more emphasis given to the side road approaches to signalised junctions. The objective was to supplement the original Bitterne survey route and to investigate how the UTC system affected the performance of the minor roads. The objective was to supplement the original Bitterne survey route and to investigate how the UTC system affected the performance of the minor roads. The surveyor and vehicle used were consistent for all surveys and the starting times were 08:00 and 17:00 on weekdays. The floating car routes for the Bitterne main route, the Bitterne side roads, and the City Centre are shown in Figures 3.14, 3.15 and 3.16 in chapter 3.3.

At the end of the demonstration phases, it was concluded that the TUC system had been demonstrated successfully, with only occasional intervention from the operator required. The weekday data provided a robust sample size for the evaluation, although a much smaller sample size was collected on Saturdays. Added to a large variability in traffic conditions on Saturdays, this meant that evaluation of the Saturday data was limited.

2.3 Munich Test Site

One distinct sub-area in the south-east of the Munich city centre was used for the SMART NETS demonstration: the old workers’ district Haidhausen with its important arterial “Rosenheimer Straße” that is used every day by many commuters. A generalized plan-of-site shows the geographical position and the road network (Figure 2.4).

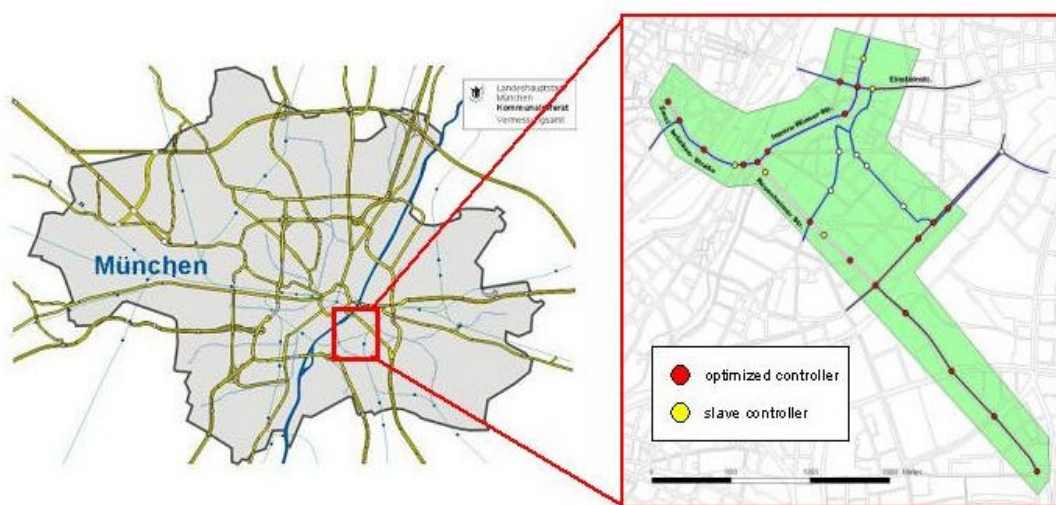

Figure 2.4 SMART NETS Trial Area in Munich

The trial area includes 25 inner urban signalised junctions and is typified by the short distance between each node with a maximum of 477 metres. This network contains a mixed residential and commercial area with high traffic demand. The second largest railway station and the biggest new commercial centre “Kustermannpark” are also contained within this trial area. In Haidhausen a big part of the transport system is based on public transport – so there are at the surface four tram lines and six bus lines. In addition there are seven suburban railway lines (subterranean) and two underground lines passing the quarter. In spite of the density of this public transport network road traffic demand is high, especially during the morning and evening peak periods.

Figure 2.5 shows a schematic representation of the signalised junctions used in the Haidhausen region. Data was collected from the majority of the approaches to each junction. All detector values of one parameter are then aggregated to one value per link. For example, where there are three detectors in one approach, the Munich assessment takes the average value of these three detectors and defines that value as the result of the link discharging into one junction.

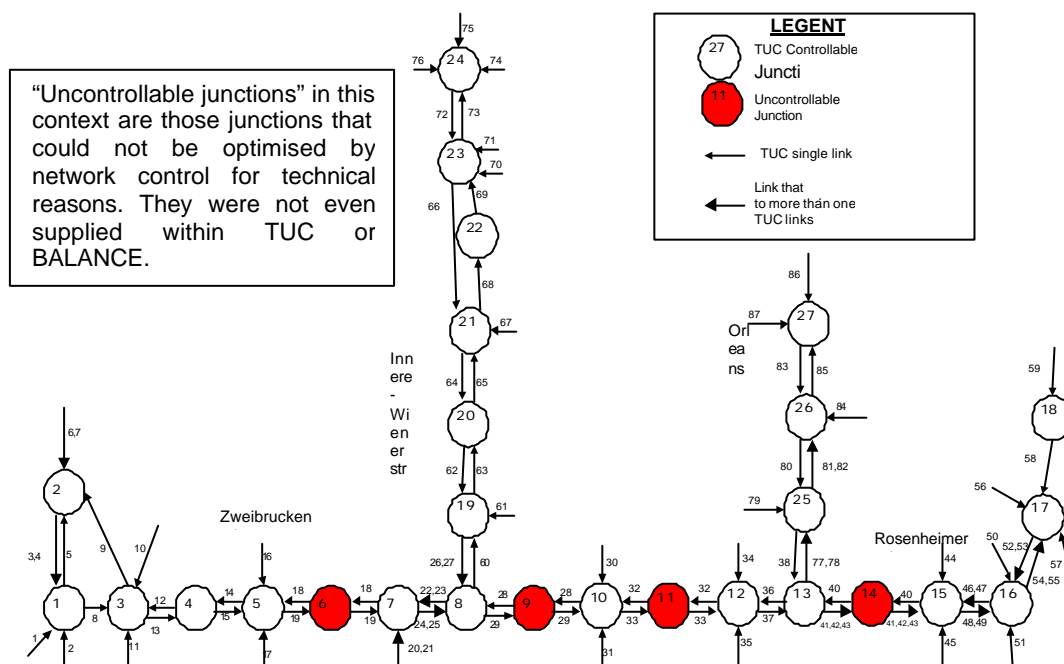

Figure 2.5 Signalised Junctions in the Munich Trial Area

TUC Demonstration Scenarios

Two different UTC control systems (or scenarios) were tested on the SMART NETS region at the Munich site. These two scenarios were:

1. BALANCE System – the cycle time, offset, and green split of each signalised junction were generated and controlled by BALANCE. Since BALANCE was the existing UTC System in use, this scenario served as the base reference case.
2. Hybrid System – this was a combination of the BALANCE and TUC systems. The cycle time of each signalised junction and the offset between the controllers were



generated by the BALANCE system but the green split, which is most important for the capacity of the network and the delays experienced by the drivers, was generated by the TUC system.

Demonstration Phase in Munich

The SMART NETS demonstration in Munich began on 19/01/04 (Monday) and ended on 15/02/04 (Sunday), a total of four weeks. Each of the two UTC system scenarios (BALANCE system; hybrid system) was in operation for a total of two weeks during the demonstration. The use of each system was rotated on a weekly basis, and each system was in operation every day from 00:00 to 24:00. The required data was based on four time-of-day-periods between 07:00 and 19:00. The raw data gathered by the control systems is complete for all 24 hours.

Data Collection

For ease of data collection, data was recorded for seven days per week and 24 hours per day for the four weeks from 19/01/04 to 15/02/04 for all UTC detectors in the network, but only the weekday data for the time period from 07:00 to 19:00 was used for further analysis, and within this, four specific time periods were selected that were of particular relevance for the evaluation:

- Weekday, morning peak hour: 07:45 – 08:45
- Weekday, a.m. peak period: 07:00 - 10:00
- Weekday, off-peak: 10:30 - 13:30
- Weekday, p.m. peak period: 16:00 - 19:00

The hourly aggregation was accomplished by several MS Access, SPSS and MS Excel calculations. Ideally, every hourly aggregated value consists of 12 values, one for every five-minute interval. In reality, most of the aggregate values (about 95%) were based on at least 10 single values; only a few of the aggregations use nine or eight data sets. Fewer than eight existing values were not aggregated to one average at all and were marked in the final tables with “no data”. Only about 0.5 % of the “No data”-Cells existed because of too few (< 8) single values.

Journey time surveys were undertaken using floating cars during the third and the fourth data collection weeks. The routes were chosen to represent a mixture of major/minor approaches to signalised junctions and a variety of congestion levels. The floating car route used in Munich is shown in Figure 3.25 in chapter 3.3. During the demonstration phase, floating car surveys were undertaken six times every weekday (survey with two cars → each car drove the route three times). The two available cars were a Mercedes A-class, starting every full hour (07:00; 08:00; 09:00), and a Ford Fusion, starting half an hour later (07:30; 08:30; 09:30). Altogether the Munich survey team drove the whole route 30 times, respectively 90 (30 * 3) route sections for both UTC scenarios.

To ensure that comparable conditions could be found to the largest possible extent, the demonstration scenarios were alternated weekly. The weather in Munich varied greatly during the four weeks of the demonstration phase. There were temperature differences up to



25 degrees comparing the coldest morning and the warmest noon; spring-like warm conditions alternated with very cold and snowy winter climate characteristics. Since the data from those periods that were most affected by the weather changes was excluded from the evaluation, it can be assumed that the data that was included in the evaluation of the two UTC system scenarios was, if at all, only affected to a minor degree.

Incidents that occurred during demonstration include roadworks and signal faults. It is important to note that the operators were not informed about every incident and there are probably some that went unreported. During the four demonstration weeks there were no known car accidents. D17 (Demonstration Report Munich) contains a detailed register of global and local detector failures, showing some minor faults, lasting only some hours and affecting only some detectors, and other detectors which did not supply data for several days or the whole test time period. After excluding the permanently faulty detectors, 38 of 57 links provided the complete data for each parameter in the database used in the evaluation of the SMART NETS demonstration.



3 Impact Assessment

3.1 Introduction

The principal aim of the TUC implementations in the three sites was to reduce traffic congestion. Therefore, this is the principal indicator used in the evaluation. Data for this assessment came from two main sources: UTC system data and floating car measurements. The results from these investigations will be discussed further below.

A second objective was to reduce, or at least not to increase, travel times for public transport. In the case of Chania, this was not investigated separately, since there are no bus priority measures in place, and buses would benefit from reduced congestion in the same way as cars. In Munich, neither TUC nor BALANCE influence public transport, since buses and trams are given priority by local controllers that are allowed to over-ride control decisions made by the central system. Neither BALANCE nor TUC were in any way an impediment to this, and therefore neither control system led to any increases in PT travel times in Munich. In Southampton, bus travel times had been observed during the verification phase, and it was concluded that TUC's bus priority was generally working appropriately, but led to problems at one particular junction; therefore the PT priority module was not switched on during the demonstration phase.

Finally, fuel consumption and emissions were derived from the measured speeds and travel times, and the results of these calculations are also discussed below.

3.2 Reduction of Traffic Congestion: UTC data

3.2.1 Weekdays

Traffic Volumes

Data concerning traffic volumes has been collected for two reasons: first of all, to ensure that comparisons between the performance of the different systems are being made for comparable traffic conditions, and furthermore to find out whether any of the systems would increase the network capacity.

If one of the systems had had any significant impact on the capacity in the controlled network, it would have been expected that there were differences between traffic flows in the surrounding network, in particular in the entry links. However, this was generally not the case, and the only links where substantially larger queues appeared under one system were located in Bitterne, where SCOOT applies deliberate gating at some key entries in order to ensure sufficient capacity within the network. As it turned out, the gating was certainly harsher than necessary, because also under TUC, where traffic on these links was allowed to enter the network more or less freely, there was never oversaturation within the network. This meant furthermore that the traffic conditions for which TUC would have been expected to be particularly effective, namely oversaturation within the network, where TUC could have potentially prevented blocking back into junctions and subsequent gridlock, never actually occurred in any of the three sites at any time under any of the four control systems.



Average network flows turned out to be in general apparently on a similar level under TUC and the resident systems unless there were obvious reasons for differences, such as special events or severe weather conditions. However, in Southampton City Centre flows generally appeared to be between 2% and 5% higher under SCOOT not only in peak periods, but also generally during the whole working day. This could not be explained by changes in capacity nor by rerouting, and other possible causes had to be considered.

Furthermore, it turned out there were differences in flows in different links at different times that were larger than expected, not only in Southampton, but also in the other sites, and this triggered further consideration and investigation. It became apparent that the known ‘masking’ problems associated with the accuracy of the detector data had more impact than anticipated. If, as for instance in the case of Southampton, the sampling of a detector is every 0.25 seconds and the effective width of a detector is 2 m, it is possible that, in congested conditions with speeds under 14 km/h, the detector cannot distinguish between two individual vehicles that follow each other at close headway. This certainly happened in all three sites and, as a result, the higher the real traffic volume becomes, the higher is the likelihood that the detectors underestimate it. For a detector located in one lane only, however, at least the trend is probably correct, even if the differences in results are not accurate in percentage terms.

In the case in Southampton, there is the additional specific problem that many SCOOT detectors straddle two lanes, which means that the detectors may not only fail to identify two cars that follow each other, but will also fail to distinguish between cars that run next to each other in parallel lanes. This latter effect clearly has a much more severe impact as it will occur much more frequently. At the outset of the project it was thought that this would still be overall acceptable, since the aim was not to identify precise vehicle numbers under each system but, instead, only to ensure comparability between systems that would be affected by masking in the same way. However, it is now being suspected that in some links even the trend may not have been correct, but masking was so severe that the phenomenon shown in Figure 3.1 occurred, where traffic volumes appear to become lower, although they still increase in reality.

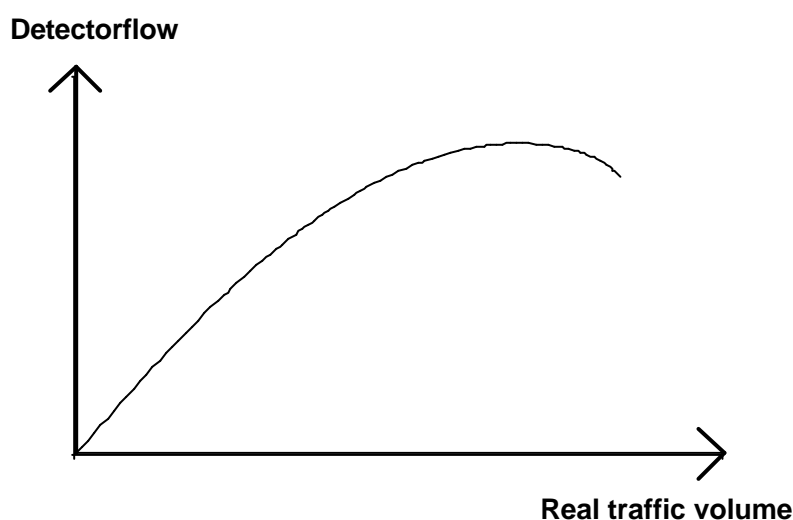

Figure 3.1 Effect of masking on measured detector flows



This effect does not only concern the directly measured flows, but it also affects occupancy measurements and therefore also speeds. Therefore, the results derived from the detector data in the following sections must be viewed with some caution.

Chania City Centre

As one of the first steps to interpreting the results of the final demonstration phase, differences in flows and occupancy were compared for each of the intervals 08:00-09:00, 14:00-15:00, 16:00-17:00 and 20:00-21:00, and the significance of these differences has been analysed with t-tests as shown in Table 3.1.

Table 3.1 Average flows and occupancies and t-test results for the final demonstration phase (Chania City Centre)

Region 1											
		08:00-09:00		14:00-15:00		16:00-17:00		20:00-21:00		All day	
		TUC	TASS	TUC	TASS	TUC	TASS	TUC	TASS	TUC	TASS
Average Occupancy		17.6	18.3	22.3	24.0	10.8	10.3	24.1	22.4	19.3	19.0
Average flows		414	426	460	456	398	390	454	460	436	440
t-test:	More Flow	0	0	5	0	1	3	0	1	1	1
TUC vs TASS	Less occupancy	3	2	3	0	0	5	0	0	2	1

The general conclusion from this is that there are differences in the results for both systems in the individual time periods, but that on average over the day the results are very similar indeed: the unweighted average of occupancies under TUC for the four key time periods is lower, i.e., better, than for TASS, but by a mere 0.3 % and the average over the entire 15 hour measurement period just 1.6 % higher. Of course, the occupancy or flow per link comparison does not take into account the link length and the number of lanes.

The calculation of mean speeds, however, does take these into account by weighing the occupancies (TTS) and the flows (TTD) with the link length and the number of lanes, and for these weighted speeds the results become clearly positive for TUC. Figure 3.2, which shows the relative difference of the average hourly mean speeds for the whole final demonstration phase, makes clear that TUC outperforms TASS in Region 1 for most of the day hours by up to 13%. The only hours where TASS performs better are the four hours from 17:00-21:00, but even in this limited period the maximum improvement by TASS is 6%.

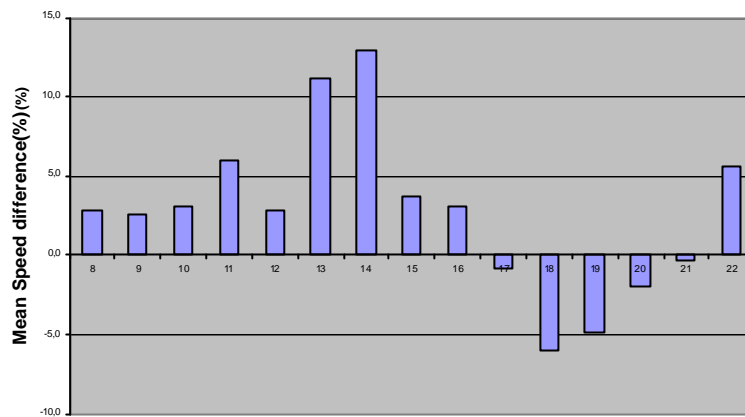

Figure 3.2 Average Mean Speed difference (%) per hour for the whole of the final demonstration phase (Chania City Centre)

As a final exercise on evaluating the two systems based on loop-detector measurements, a different tool of analysis was used with a curve-fitting analysis on TTD versus Mean Speed points. More precisely, a second order polynomial was used and fitted it into TTD vs Mean Speed points. The two resulting curves are shown in Figure 3.3. These results demonstrate the superiority of the mean speeds for TUC over TASS.

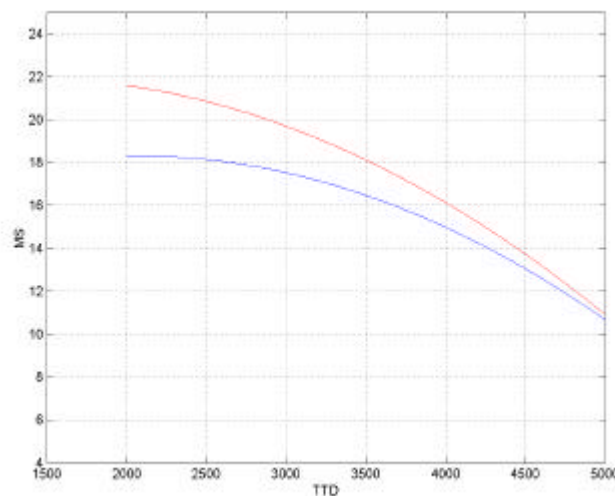

Figure 3.3 TUC (red curve) vs TASS (blue curve) for Mean Speeds in Chania City Centre in the final demonstration phase

Chania East Entrance

Table 3.2 shows the average flows and occupancies as well as the ttest results for this region. The general conclusion from this table is that the results for both systems are similar, and the same conclusion can be drawn from a comparison of the average hourly mean speeds for the two systems, as shown in Figures 3.4 and 3.5.



Table 3.2 Average flows and occupancies and t-test results for the final demonstration phase (Chania Region 2)

Region 2											
		08:00-09:00		14:00-15:00		16:00-17:00		20:00-21:00		All day	
		TUC	TASS	TUC	TASS	TUC	TASS	TUC	TASS	TUC	TASS
Average Occupancy		24.5	23.8	27.1	25.4	13	14.1	19.2	20.2	18.7	19.0
Average flows		425	445	573	572	469	474	508	506	486	492
t-test:	More Flow	0	0	1	0	0	0	0	0	1	0
TUC vs TASS	Less occupancy	0	0	1	0	2	0	0	2	0	0

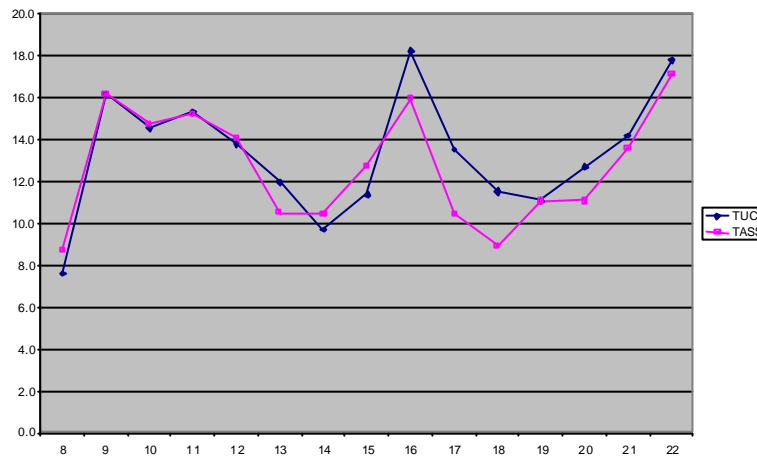

Figure 3.4 Average Mean Speed per hour for weeks 1 and 2 of final demonstration phase (Chania Region 2)

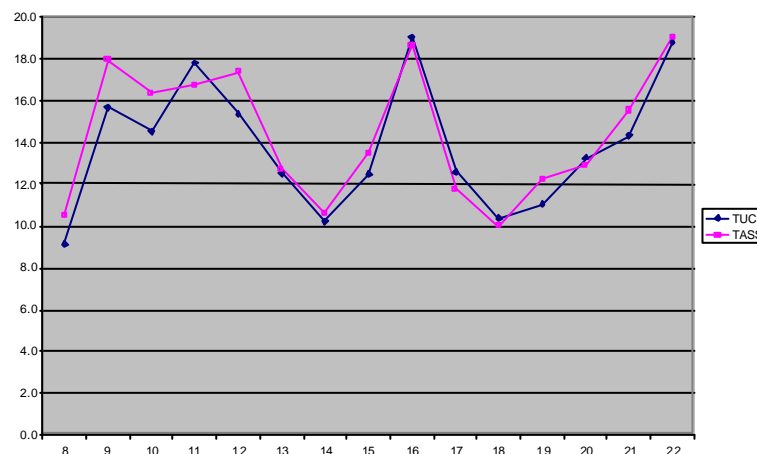

Figure 3.5 Average Mean Speed per hour for weeks 3 and 4 of final demonstration phase (Chania Region 2)

These results were not unexpected, since the problem with the two junctions of this region is not the implementation of an efficient real-time strategy (with TASS already employing a specially designed efficient second-by second cycle time extension technique in one of the



two junctions of this region). It seems that any real-time strategy cannot improve the traffic conditions in these two junctions further, and that a modification in the geometry and the staging of junction K12 is needed. Chania city council has already looked into this and is planning to apply modifications to the geometry and the staging of junction K12.

Southampton

The global effects of each UTC system scenario were considered by averaging results across all detectors within each of the City Centre and Bitterne regions for the following time intervals: weekday a.m. peak (08:00-09:00), weekday off-peak (12:00-13:00), weekday p.m. peak (17:00-18:00) and weekday aggregated data (07:00-19:00). The average speeds and ALOTPVs (Average Loop Occupancy Time Per Vehicle) were derived by factoring the individual detector values according to the detector flow. Furthermore, harmonic speeds (which are factored by flow and link length) were calculated for overall network results, which is in line with Chania and Munich, where the harmonic speeds were the main indicator used.

Table 3.3 shows the regional results for Bitterne from the second demonstration phase for each UTC system scenario, time interval and region. The ALOTPVs obtained from the SCOOT and TUC systems were overall similar for the Bitterne region, with values for TUC higher during the off-peak and for SCOOT in the p.m. peak.

Table 3.3 Comparison of Southampton Bitterne Regional Results

Time Interval	Speed				ALOTPV	
	Mean Speeds (Factored by flow)		Harmonic Speeds (Factored by flow and link length)		SCOOT	TUC
	SCOOT	TUC	SCOOT	TUC		
08:00-09:00	30.3	29.1	22.8	27.0	612	625
12:00-13:00	34.2	34.0	33.6	33.9	362	404
17:00-18:00	31.2	31.1	29.0	29.7	540	511
07:00-19:00	33.6	33.3	22.8	27.0	425	432
Sat: 11:00-12:00	34.9	36.3	33.5	36.0	408	336

The mean speeds are roughly in line with the ALOTPV values, apart from a 4% increase in speed under SCOOT during the a.m. peak. The harmonic speeds, however, change the picture entirely: with this criterion, TUC outperforms SCOOT in every single time interval. This is a remarkable result, even if the harmonic speeds are regarded as somewhat dubious in Southampton, and in particular in Bitterne, for two reasons:

- First of all, in Southampton the speeds were derived from direct loop measurements and are therefore highly dependent on the location of the detector within the link. Furthermore, the detector location has not been chosen to achieve the most representative speed measurement, but the most appropriate input for the SCOOT optimisation. Especially in long links, the speeds at the detectors may not always be representative of the average speed over the whole link.
- The even more significant problem is the definition of the link length. In a closed network it is relatively straightforward to define the link as the distance between the upstream and downstream signal or stop-line. For entry links, and even more so for links crossing an arterial such as the Bitterne corridor, the link definition is much more



subjective and arbitrary. The most prominent example for this problem is Bitterne Road East (with detector 34), which has been defined as being 1.7 km long, since this is generally the maximum distance to which the traffic, which is deliberately gated here by SCOOT, queues back in the morning peak. The detector in this link is, however, located only 100 metres upstream of the signal. Every time when this detector detects very slow moving traffic, the harmonic mean assumes that this slow traffic exists on the whole 1.7km road stretch, while even in the morning peak this will only be true for part of the time, and it will hardly ever occur at other times of the day.

For the City Centre Region (Table 3.4), the average ALOTPV was substantially lower under SCOOT control by about 25% for the a.m. peak and 15% for the p.m. peak. If masking had an impact on the measured traffic volumes, then it would also affect the average per vehicle occupancy by indicating exaggerated ALOTPV values for TUC, albeit not to an extent that would fully explain the difference between SCOOT and TUC in the City Centre.

Table 3.4 Comparison of Southampton City Centre Regional Results

Time Interval	Speed				ALOTPV	
	Mean Speeds (Factored by flow)		Harmonic Speeds (Factored by flow and link length)			
	SCOOT	TUC	SCOOT	TUC	SCOOT	TUC
08:00-09:00	31.7	30.0	27.7	26.2	464	613
12:00-13:00	31.3	31.4	31.6	31.5	412	429
17:00-18:00	29.8	28.7	28.0	27.6	619	710
07:00-19:00	31.6	31.2	31.3	31.0	449	494
Sat: 11:00-12:00	28.6	32.1	27.4	33.0	913	462

The findings for mean speeds are roughly in line with the ALOTPV values: the speed increased under SCOOT during the a.m. and p.m. peaks (about 5% and 4%, respectively). In contrast to Bitterne, the calculation of harmonic speeds for the City Centre does not lead to results that differ to any relevant extent from the mean speeds.

As was the case for Chania, the data gathered was analysed using t-tests, and Table 3.5 shows, for each region and time interval, the number of detectors that produced significantly different results. Note that a total of 51 detectors were used from the Bitterne region, 96 from the City Centre and 11 ‘others’ from outside the SMART NETS test sites.

For the Bitterne region, it can be seen that in the a.m. peak 10 of the 51 detectors produced a significantly higher flow under SCOOT control whereas 7 (other) detectors produced a higher flow under TUC, while during the off peak and p.m. peak, there were much fewer detectors with significant differences. This is also true of the speed and ALOTPV Bitterne results, although it should be noted that for no time interval does the number of detectors producing significantly ‘favourable’ results under TUC exceed the equivalent SCOOT value. A comparison of this result with the corresponding findings in the first evaluation phase provides evidence that the fine-tuning of TUC was successful, i.e., the difference in performance between the SCOOT and TUC systems has narrowed.



Table 3.5 Number of Detectors with Significantly Different Results for SCOOT vs TUC Scenarios (Southampton)

Parameter	Region	08:00-09:00		12:00-13:00		17:00-18:00	
		SCOOT	TUC	SCOOT	TUC	SCOOT	TUC
Higher Flow	Bitterne	10	7	4	2	4	4
	City	26	5	15	1	13	3
	Others	3	0	0	0	0	0
Higher Speed	Bitterne	12	7	10	9	11	5
	City	24	17	9	13	13	7
	Others	0	2	0	0	0	0
Less ALOTPV	Bitterne	12	6	8	5	8	8
	City	20	14	11	9	14	3
	Others	0	0	0	0	0	0

As already indicated by the average speeds and ALOTPVs, the results from the second demonstration phase for the City Centre were slightly disappointing for TUC for the peak hours. Although the gap in performance with SCOOT has narrowed since the first demonstration, any improvement is only marginal. For example, during the p.m. peak, SCOOT outperformed TUC by a ratio of 14:3 on ALOTPV.

Maps were plotted showing the locations of the detectors that had significantly different flows and ALOTPVs. For the Bitterne region in the a.m. peak, the detectors that performed better under TUC were located on the outskirts of the Bitterne region, while those benefiting under SCOOT were located on the corridor approach to the City Centre. However, during the off-peak and p.m. peak, there were fewer detectors producing significant differences during the second demonstration phase and so no general conclusions can be drawn regarding clustering of their locations, implying that the performance level of TUC was approximately equal to that of SCOOT. Indeed, in the Bitterne region, it is probable that the main differences in the a.m. peak between the two systems were directly related to the ‘harsh’ gating used in conjunction with SCOOT, rather than any differences in the TUC systems themselves. For the City Centre, the SCOOT improvements in the peak periods were mainly centred on West Quay Road. However, the benefits under SCOOT elsewhere in the City Centre network appeared less pronounced than in the first demonstration phase. These findings provide further evidence that the fine-tuning of TUC during the summer had a positive effect.

Munich

A variety of indicators have been used for the impact assessment of the BALANCE/TUC hybrid (also referred to “TUC”) and the reference case BALANCE. Unfortunately, there have been problems with the reliability of all of them:

- Floating Car Data (FCD) is normally the most reliable source for travel times, but unfortunately 74% of the FCD data had to be excluded due to technical reasons or incidents. This meant that the number of trips available for evaluation was very low and, since journey times varied quite strongly for the same route under the same



when TUC is running, during weeks 3/4 it is 2.4% lower even with slightly higher flow values. Values for most time periods do not differ too much between weeks and between systems, with two remarkable exceptions:

- Weeks 3/4: during the off-peak period, occupancy is reduced by nearly 10% with TUC when flow is reduced by 2%.
- Weeks 1/2: during the evening peak, occupancy is 7.9% higher with TUC, but flow is nearly unchanged.

For both phenomena no explanation could be found.

Table 3.6 Summarized Occupancy and Tailback Values (Munich)

Occ [%] for each time-of-day period											
Occ. [%]	Weekday 07:45 to 09:45		Weekday 07:00 to 10:00		Weekday 10:30 to 13:30		Weekday 16:00 to 19:00		Weekday 09:00 to 19:00		
	BAL	BAL TUC	BAL	BAL TUC	BAL	BAL TUC	BAL	BAL TUC	BAL	BAL TUC	
Comparison of Week 1 and 2											
Total	19,9	20,5	20,0	20,5	17,3	17,6	23,0	24,8	19,7	20,6	
% diff.	2,9%		2,4%		1,5%		7,9%		4,7%		
Comparison of Week 3 and 4											
Total	21,3	21,8	21,0	20,9	20,0	18,1	24,8	24,5	21,9	21,4	
% diff.	2,5%		-0,6%		-9,8%		-1,1%		-2,4%		
Average of ALL weeks (average of weeks 1/2 and weeks 3/4)											
Total	20,6	21,2	20,5	20,7	18,7	17,8	23,9	24,6	20,8	21,0	
% diff.	2,7%		0,9%		-4,5%		3,2%		1,0%		
Tailback [veh] for each time-of-day period											
Tailback [veh]	Weekday 07:45 to 09:45		Weekday 07:00 to 10:00		Weekday 10:30 to 13:30		Weekday 16:00 to 19:00		Weekday 09:00 to 19:00		
	BAL	BAL TUC	BAL	BAL TUC	BAL	BAL TUC	BAL	BAL TUC	BAL	BAL TUC	
Comparison of Week 1 and 2											
Total	8,3	9,6	8,5	9,9	7,1	7,2	9,2	10,6	8,0	8,7	
% diff.	15,6%		15,9%		1,2%		14,8%		7,8%		
Comparison of Week 3 and 4											
Total	7,4	7,8	6,5	7,4	6,7	5,8	9,9	9,4	7,6	7,5	
% diff.	6,4%		14,9%		-13,4%		-5,2%		-1,1%		
Average of ALL weeks (average of weeks 1/2 and weeks 3/4)											
Total	7,8	8,7	7,5	8,6	6,9	6,5	9,6	10,0	7,8	8,1	
% diff.	11,3%		15,5%		-5,9%		4,5%		3,5%		

The corresponding view on the tailback estimations run by the UTC system shows very strong advantages for BALANCE in both pairs of weeks for the morning peak hours which, in the light of the aforementioned uncertainties of the tailback estimation and the fact that there is no explanation why tailback should differ to such a degree from occupancy, is open to questioning. The aforementioned phenomena during the p.m. peak hours in weeks 1/2 and during the off-peak period on weeks 3/4 are, however, also repeated by the tailback estimations.

Speed values and travel times are calculated in the Munich trial by using average queue lengths. These average queue lengths are deduced from the estimated tailback. The algorithm to calculate average queue lengths from tailbacks assumes that average queue lengths are proportional to the red time within a cycle.

Table 3.7 shows the overall results of speed and travel time evaluation, averaged on all links for all calculated time-of-day periods. In the same way in which there are differences between occupancy and tailback data, there are also differences between speed and travel time data. In this case, one possible explanation is the existence of short and long links and



the fact that speed averages do not take link lengths into account, but travel times do. This was one of the reasons to also calculate harmonic speeds, which take this effect into account.

Table 3.7 Summarized Speed and Travel Time Values (Munich)

Speed [km/h] for each time-of-day period										
Speed [km/h]	Weekday 07:45 to 09:45		Weekday 07:00 to 10:00		Weekday 10:30 to 13:30		Weekday 16:00 to 19:00		Weekday 09:00 to 19:00	
	BAL	BAL TUC	BAL	BAL TUC	BAL	BAL TUC	BAL	BAL TUC	BAL	BAL TUC
Comparison of Week 1 and 2										
Total	14,2	13,9	14,1	13,6	14,7	14,9	14,0	13,5	14,3	14,2
% diff.	-2,1%		-3,8%		1,0%		-3,2%		-1,0%	
Comparison of Week 3 and 4										
Total	15,5	15,1	15,9	15,2	15,1	14,8	14,5	13,7	14,5	14,1
% diff.	-2,9%		-3,9%		-1,7%		-5,4%		-3,2%	
Average of ALL weeks (average of weeks 1/2 and weeks 3/4)										
Total	14,9	14,5	15,0	14,4	14,9	14,8	14,3	13,6	14,5	14,2
% diff.	-2,5%		-3,9%		-0,4%		-4,3%		-2,1%	

Travel Time [s] for each time-of-day period										
Travel time [s]	Weekday 07:45 to 09:45		Weekday 07:00 to 10:00		Weekday 10:30 to 13:30		Weekday 16:00 to 19:00		Weekday 09:00 to 19:00	
	BAL	BAL TUC	BAL	BAL TUC	BAL	BAL TUC	BAL	BAL TUC	BAL	BAL TUC
Comparison of Week 1 and 2										
Total	57,4	55,9	57,7	57,4	54,0	53,2	59,6	59,6	56,2	55,8
% diff.	-2,7%		-0,6%		-1,5%		-0,1%		-0,6%	
Comparison of Week 3 and 4										
Total	55,3	56,4	54,0	56,8	51,2	51,3	55,7	56,9	52,8	53,8
% diff.	1,9%		5,1%		0,1%		2,0%		1,8%	
Average of ALL weeks (average of weeks 1/2 and weeks 3/4)										
Total	56,4	56,1	55,9	57,1	52,6	52,2	57,7	58,2	54,5	54,8
% diff.	-0,4%		2,2%		-0,7%		0,9%		0,6%	

As indicated before, differences between the two sets of weeks are reduced when the data is compared for only those links which provided data for all four weeks (Table 3.8). Travel times, which were overall slightly lower for BALANCE for all links that could be evaluated in either set of weeks, are now indistinguishable for both systems for the 11-hour day period. This means that, by pure chance, a lower number of links where BALANCE performed better provided data for all four weeks. But since the trend, even if not the magnitude, is the same for speeds for the two sets of weeks (+0.2% and +1.2 %), and absolutely the same for travel times (-0.6% and -0.6%), it can be concluded that using all detectors that are available in either week for the evaluation does not distort the results, but instead gives a fuller picture of the overall network.

Harmonic speed was chosen as a parameter to join the overall travel time and the overall travelled distance into one comparable indicator for the traffic quality during the two scenarios.



Table 3.8 Summarised Speed and Travel Time Values (Munich, 4-week-values)

Speed [km/h] for each time-of-day period										
Speed [km/h]	Weekday 07:45 to 09:45		Weekday 07:00 to 10:00		Weekday 10:30 to 13:30		Weekday 15:00 to 18:00		Weekday 08:00 to 19:00	
	BAL	BAL TUC	BAL	BAL TUC	BAL	BAL TUC	BAL	BAL TUC	BAL	BAL TUC
Comparison of Week 1 and 2										
Total	15,7	15,2	15,6	14,8	15,2	15,6	14,7	14,3	14,9	14,8
% diff.	-2,9%		-4,9%		2,4%		-3,2%		-0,8%	
Comparison of Week 3 and 4										
Total	15,5	15,1	15,9	15,1	15,6	15,3	14,1	14,0	15,0	14,8
% diff.	-2,6%		-4,9%		-1,5%		-0,5%		-2,0%	
Average of ALL weeks (average of weeks 1/2 and weeks 3/4)										
Total	15,6	15,2	15,7	15,0	15,4	15,5	14,4	14,1	15,0	14,8
% diff.	-2,8%		-4,9%		0,4%		-1,9%		-1,4%	

Travel Time [s] for each time-of-day period										
Travel time [s]	Weekday 07:45 to 09:45		Weekday 07:00 to 10:00		Weekday 10:30 to 13:30		Weekday 15:00 to 18:00		Weekday 08:00 to 19:00	
	BAL	BAL TUC	BAL	BAL TUC	BAL	BAL TUC	BAL	BAL TUC	BAL	BAL TUC
Comparison of Week 1 and 2										
Total	59,5	59,5	59,8	61,1	54,2	52,4	57,7	57,4	55,9	55,2
% diff.	0,1%		2,3%		-3,3%		-0,5%		-1,2%	
Comparison of Week 3 and 4										
Total	57,8	58,7	56,2	59,6	52,2	52,0	57,7	58,2	54,2	54,8
% diff.	1,5%		6,0%		-0,4%		0,8%		1,2%	
Average of ALL weeks (average of weeks 1/2 and weeks 3/4)										
Total	58,6	59,1	58,0	60,3	53,2	52,2	57,7	57,8	55,0	55,0
% diff.	0,8%		4,1%		-1,9%		0,2%		0,0%	

Table 3.9 shows the results of the calculations. They are based on the measured flow and the UTC estimation of travel times via tailbacks. Again, they show overall a slightly better performance for BALANCE, but with a notable difference between the two sets of weeks, where TUC slightly outperforms BALANCE in the first set. The harmonic speeds were then used as a basis for the part of the socio-economic assessment that was based on UTC data (see chapter 5).

Table 3.9 Harmonic speeds (Munich)

Harm. Speed [km/h] for each time-of-day period										
Harm. Speed [km/h]	Weekday 07:45 to 09:45		Weekday 07:00 to 10:00		Weekday 10:30 to 13:30		Weekday 15:00 to 18:00		Weekday 08:00 to 19:00	
	BAL	BAL TUC	BAL	BAL TUC	BAL	BAL TUC	BAL	BAL TUC	BAL	BAL TUC
Comparison of Week 1 and 2										
Total	14,0	14,0	13,7	13,7	14,9	15,4	13,8	13,8	14,4	14,5
% diff.	0,4%		-0,3%		3,1%		0,3%		1,0%	
Comparison of Week 3 and 4										
Total	15,8	15,3	16,2	15,3	17,1	16,5	15,8	15,3	16,3	15,8
% diff.	-3,0%		-5,7%		-3,5%		-2,8%		-3,0%	
Average of ALL weeks (average of weeks 1/2 and weeks 3/4)										
Total	14,9	14,7	15,0	14,5	16,0	15,9	14,8	14,6	15,3	15,1
% diff.	-1,4%		-3,2%		-0,4%		-1,3%		-1,1%	

3.2.2 Saturdays

Saturday data was only evaluated separately in Southampton, since Saturday lunchtimes are showing the worst congestion problems of the entire week in the City Centre. In Munich, Saturday data has not been included in the evaluation at all, and in Chania it has been analysed in conjunction with the week-day data.

Unfortunately, the data available for Saturdays in Southampton was too limited to be of statistical significance, but it did show a remarkable performance for TUC. UTC data was collected for two days per system and two journey time surveys were also undertaken on each Saturday during the second demonstration phase. On the first Saturday at 14:00 there was extremely heavy congestion on West Quay Road, which TUC could not clear so the operator intervened and used manual signal plans to clear the congestion, which meant that all Saturday p.m. data was excluded from the evaluation. A similar problem happened the following Saturday during SCOOT operation. As a result of these occurrences, the quantity of floating car data collected on Saturdays was limited to just two periods per UTC system scenario for the 11:00 start and just one each for the 14:00 start.

Figure 3.7 compares the speed differences obtained on the four Saturdays from the 11:00-12:00 time interval. This figure indicates a very drastic improvement by TUC over SCOOT, but since the basis for this comparison was only two measurements per system and it was known that weather and traffic conditions varied considerably between these Saturdays, this finding was treated with some caution and triggered some more in-depth investigation.

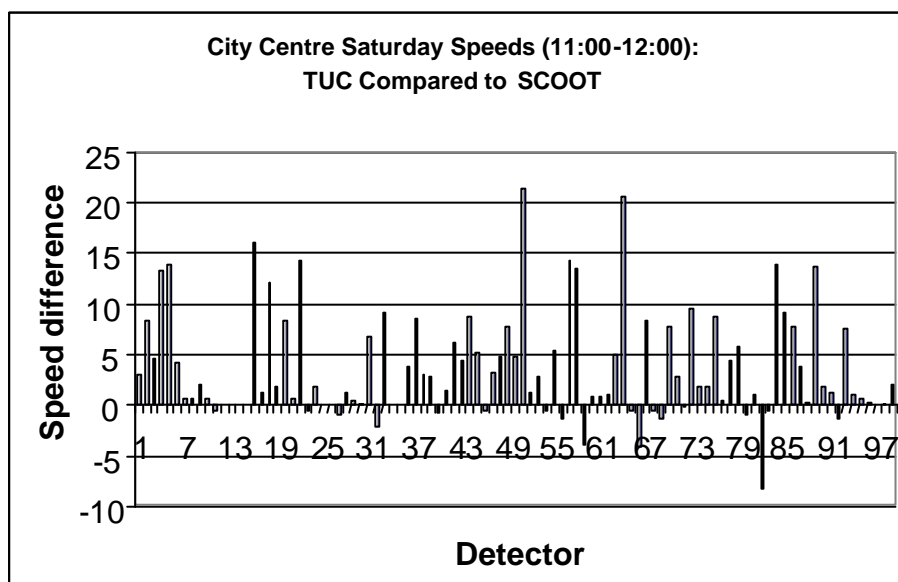

Figure 3.7 Comparison of SCOOT vs TUC – Speed Differences in Southampton City Centre, Saturday

Furthermore, the floating car data showed extreme variability:

- The overall route journey time under SCOOT was 1,374 seconds (11:00 start) for the first Saturday, but 4,534 seconds (11:00 start) and 4,356 seconds (14:00 start) during the second SCOOT Saturday.
- For TUC, the corresponding journey times were 1,584 seconds (11:00 start) during the first Saturday, but 1,342 seconds (11:00 start) and 5,000 seconds (14:00 start) for the second TUC Saturday.

So, on the first set of Saturday mornings and the two Saturday afternoons, journey times were about 15% higher under TUC than under SCOOT, but on the second set of Saturday mornings, the SCOOT journey time was more than three times that under TUC.



Furthermore, both of the afternoon travel times, for TUC as well as for SCOOT, were also more than three times higher than those for the same system on the first Saturday mornings.

One clear difference between the four Saturdays was that the first two of these Saturdays (one with TUC and one with SCOOT) were dry and sunny, but in the following two weeks it was raining heavily, making driving conditions more difficult. This affected both systems in the same way, and it could potentially explain the threefold travel time increase of the wet Saturday afternoons over the dry Saturday mornings. However, the fact that congestion on both of the dry afternoons had been so heavy that both systems had to be switched off because they couldn't cope suggests that the huge increase in travel times might have been less an effect of weather than of changed traffic conditions in the afternoons. Furthermore, an analysis of the data for the Bitterne Region showed not only that there was no discernable difference between the performance of SCOOT and TUC on Saturdays, but also that the speeds in wet weather conditions were only 2% lower than in dry weather.

On the third Saturday, when TUC was running, the Rugby World Cup Final was being televised, watched by a wide audience, and ended at about 11:30. This meant there was much less traffic on the City Centre road network during the morning hours compared to normal Saturdays. (It was also thought possible that traffic volumes were affected by the fact that Southampton FC played at home during the third Saturday with kick off at 15:00, but the data showed no evidence for that.)

Table 3.10 shows the average hourly flows for each day. In addition to the hours considered within the evaluation (highlighted in bold numbers), the preceding time period was also considered to see if this could aid the interpretation. To ensure consistency between the different Saturdays, detectors that had any missing hourly values on Saturday mornings were excluded from this analysis (i.e., all data was analysed from the same detectors, and results are comparable between time slices). A total of 87 detectors was used.

Table 3.10 Average Southampton City Centre Flows during Saturdays

Time Interval	Average Flow Per Detector (vehs) on each Saturday			
	1 (TUC)	2 (SCOOT)	3 (TUC)	4 (SCOOT)
08:00-09:00	255	274	286	297
09:00-10:00	381	379	333	393
10:00-11:00	435	419	348	421
11:00-12:00	488	492	438	440
12:00-13:00	N/a	N/a	531	471
13:00-14:00	N/a	N/a	484	478
14:00-15:00	N/a	N/a	484	471

The effect of the rugby is very apparent. However, by the time the floating car measurements started at 11:00, flow levels on Saturday 3 and 4 were nearly the same again. Given, furthermore, that flows reached an all-time high from 12:00 to 13:00 on the rugby Saturday, it becomes very obvious that many people who would have normally travelled into the city but watched the rugby on that morning, rushed out as soon as the match finished around 11:30.



Table 3.11 then shows the speeds measured in the City Centre by the detectors during the same hours, and Figure 3.8 relates the journey times measured by floating cars to the speeds measured by the detectors at the same time.

Table 3.11 Average Southampton City Centre Speeds during Saturdays

Time Interval	Average Speed Per Detector (km/hr) on each Saturday			
	1 (TUC)	2 (SCOOT)	3 (TUC)	4 (SCOOT)
08:00-09:00	36.6	36.2	35.2	35.1
09:00-10:00	34.8	34.0	34.3	29.2
10:00-11:00	33.3	33.0	33.6	27.1
11:00-12:00	31.1	31.5	32.5	24.0
12:00-13:00	N/a	N/a	26.7	23.4
13:00-14:00	N/a	N/a	22.4	25.1
14:00-15:00	N/a	N/a	21.2	26.7

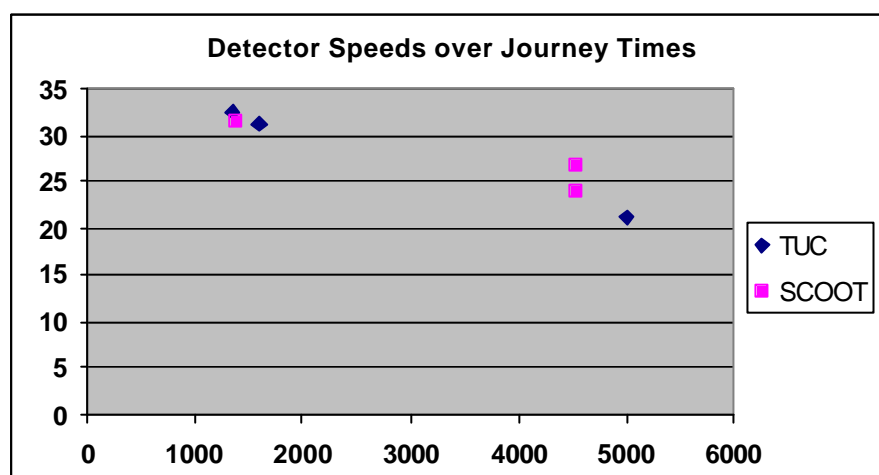

Figure 3.8 Comparison of SCOOT vs TUC – Speeds and Journey Times in Southampton City Centre, Saturday

Figure 3.8 shows, as far as the small amount of data allows, a very strong correlation between detector speeds and floating car journey times, which gives some credence to the assumption that the journey times, in spite of their variability, were a true representation of the speeds in which traffic could move through the network during those hours.

Figure 3.9 plots the speeds for TUC and SCOOT over traffic flows separately for the two Saturday mornings and the one Saturday afternoon. For dry weather, both TUC and SCOOT are virtually on one line but, remarkably, TUC speeds drop off only very marginally from this line in wet weather on the following Saturday morning. SCOOT starts on a similar point as TUC, but then has to cope with more traffic than TUC for the next two hours, and speeds drop very severely during that time. At 11.00, when traffic levels are nearly the same for both systems, speeds under TUC are 35 % higher than under SCOOT. It seems likely that at least some of this difference comes from the fact that under SCOOT, traffic levels and congestion built up gradually during the morning while on the TUC day, with rugby going on, the heavy lunchtime traffic hit a still free-flowing network, which could therefore better accommodate the sudden onslaught. However, it is still very remarkable how well TUC



coped with the sudden increase in traffic, keeping traffic speeds (and floating car journey time) at the same level as on the previous dry weather morning. Moreover, even in the following hour, when TUC had to cope with 8% more flow than SCOOT had at any time, the speed still stayed at nearly 27 km/h, extending the line drawn by both systems at dry weather and TUC's own line of that morning. Looked at from a different perspective, under SCOOT the speed already drops to 27.1 km/h at a flow of 421 veh/h, while under TUC the drop to 26.7 km/h only occurs at 531 veh/h, i.e., a 26% higher flow. Only after that stage, also under TUC, the network can't cope with the traffic any longer and speeds drop under TUC as well, even to the lowest level of any of the hours under investigation.

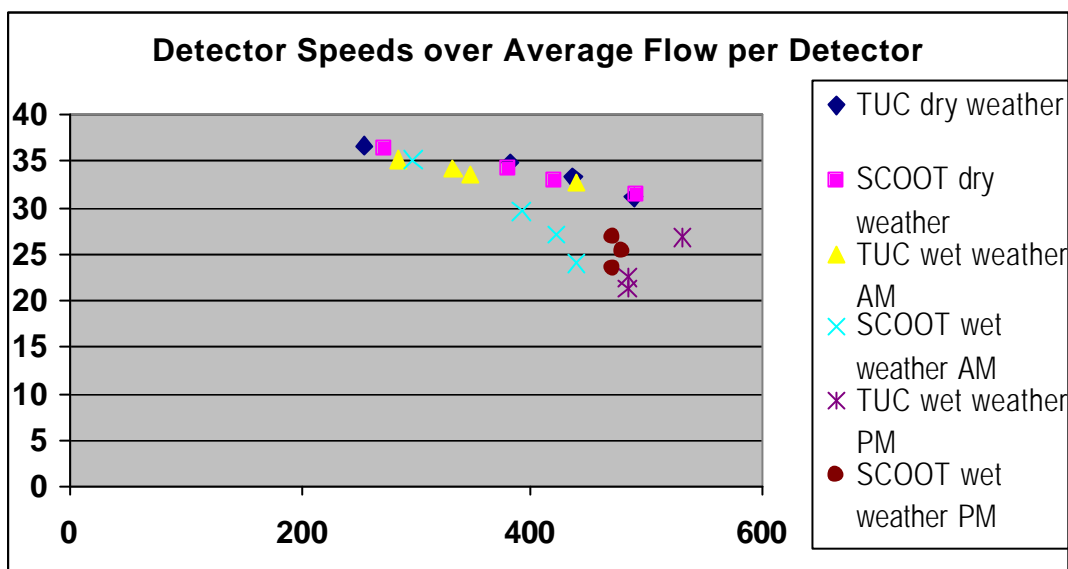

Figure 3.9 Comparison of SCOOT vs TUC – Speeds and Flows in Southampton City Centre, Saturday

Overall, the indication is that, while in Bitterne TUC performed as well as SCOOT, in the City Centre TUC outperformed SCOOT on Saturdays. It is unfortunate that the amount of available data is too small to allow any statistically significant conclusions to be drawn.

3.3 Reduction of Traffic Congestion: Floating Car Measurements

Chania

During the final demonstration period, the following floating car measurements were performed:

- Tuesdays starting times 11:30 am and 7:30 pm
- Wednesdays starting times 11:30 am and 7:30 pm
- Thursdays or Fridays starting time 7:30 pm
- Saturdays starting time 12:00 noon

Each time, one or two trips were performed (which lasted from 30 up to 65 minutes). On Tuesdays, Thursdays and Fridays, shops are open both in the morning and in the afternoon,

on Wednesdays shops are open only in the mornings, while on Saturdays traffic has an altogether different pattern than the weekdays (shops are open but offices are closed; most people go shopping on Saturdays).

The route (Figure 3.10) covers all of the most heavily trafficked sections of the Chania network, which are also at the same time the sections that are most likely to be affected by illegal/double parking during the shop opening hours. The route covers both the City Centre (Region 1) and the East Entrance Region (Region 2) in one single journey, but for the analysis of the measurements, the route is split with the first two and last three links in the route assigned to the East Entrance Region and all other sections to the City Centre.

With the exception of a small part of the floating car route from junction K17 to junction K1, all the rest of the links covered by the floating car routes are within the TUC control area. This link outside the TUC control area has been excluded from the evaluation.

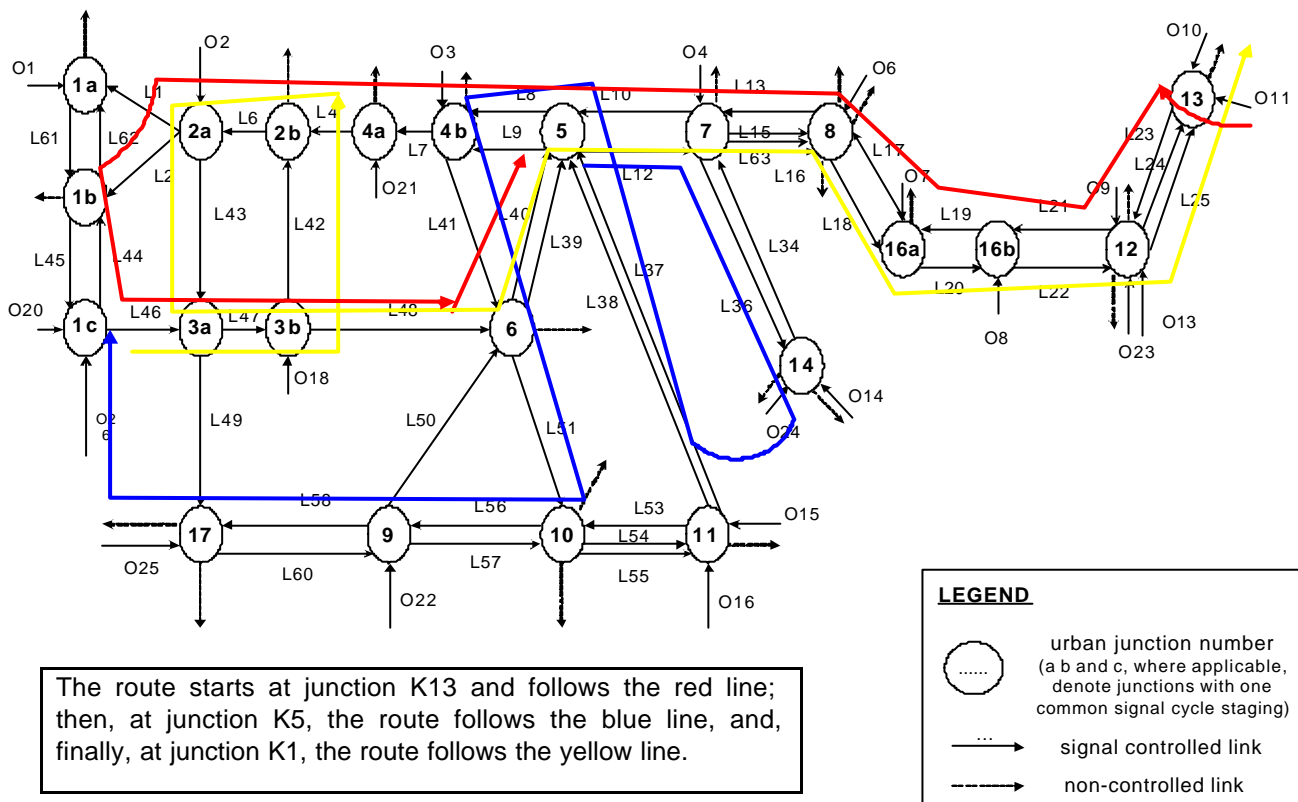
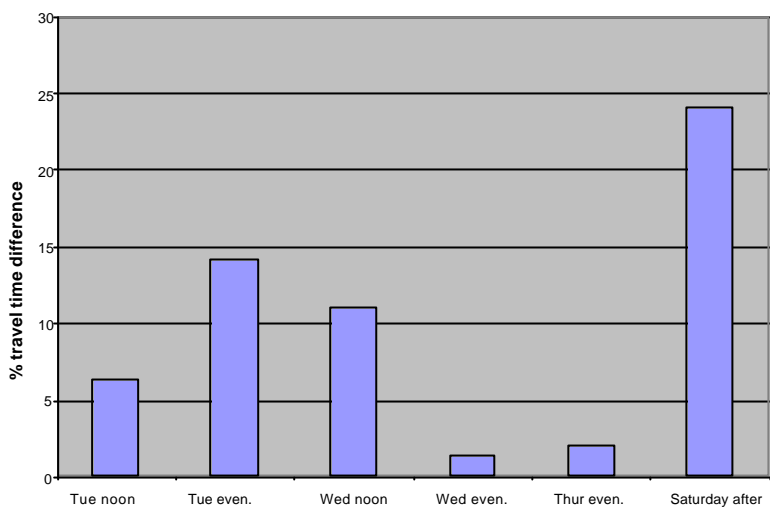

Figure 3.10 Map of Floating Car Route in Chania

Figure 3.11 shows the relative difference of the average travel times for the two systems (TUC versus TASS) for the overall City Centre Region, while Figure 3.12 shows the relative difference of the average travel times only for the “heavy” network links (that is, by excluding links that rarely get congested and are far from the main congestion areas of the network).



In this plot, positive per cent travel time difference corresponds to less total travel time for TUC, and negative per cent travel time difference corresponds to less total travel time for TASS.

Figure 3.11 Average Travel Time Difference (%) for Floating Car Measurements (Chania Region 1)

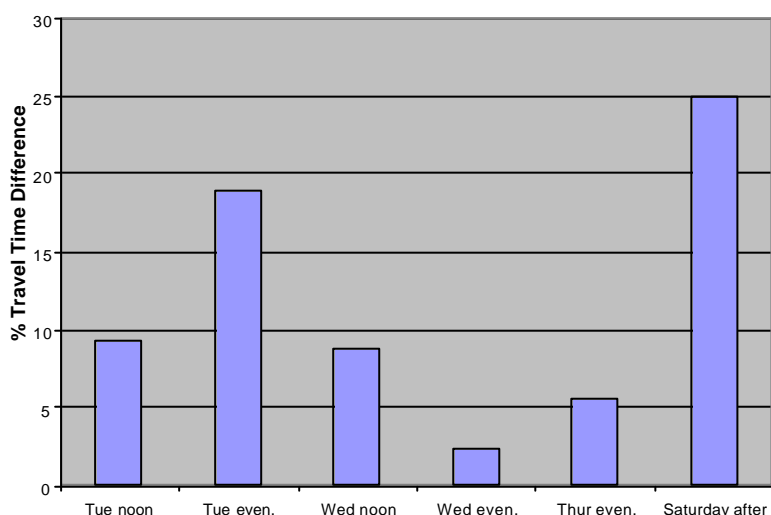

In this plot, positive per cent travel time difference corresponds to less total travel time for TUC, and negative per cent travel time difference corresponds to less total travel time for TASS.

Figure 3.12 Average Travel Time Difference (%) for Floating Car Measurements (Chania Region 1, Heavy Links)

The main conclusion from these figures is that TUC clearly outperforms TASS in Region 1, and especially at links with heavy congestion, where TUC shows an improvement of 5%-25% during peak-hours and a slight improvement over off-peak times (Wednesday evening). Results based on floating car measurements are deemed to be more reliable and accurate than results that are based on detector measurements (due to questions concerning accuracy of flow measurements, as already pointed out, and the fact that these flows are then used to calculate mean network speeds). In other words, the comparisons based on the detector measurements show that TUC, in general, performs better than TASS although they do not accurately show the exact level of improvement. This level of improvement is clearly shown in Figures 3.11 and 3.12, where the superiority of TUC, especially during peak hours, is demonstrated.

Figure 3.13 shows the per cent difference of the average travel times for the two systems for the East Entrance Region. Each system performs better at different time periods, albeit advantages for TASS have been found at more measurements and at a greater level. However, the differences are not clear enough to indicate a general superiority of the one system over the other. Moreover, since this floating car route only contains five links, the results shown in Figure 3.13 may be significantly affected by the stochastic nature of the traffic.

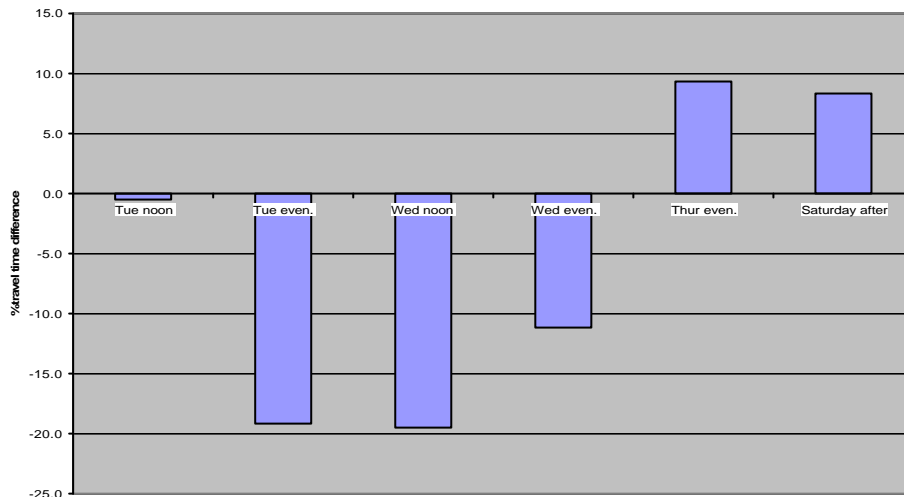

In this plot, positive per cent travel time difference corresponds to less total travel time for TUC, and negative per cent travel time difference corresponds to less total travel time for TASS.

Figure 3.13 Average Travel Time Difference (%) for Floating Car Measurements (Chania Region 2)

Southampton

The floating car routes used in Southampton are shown in Figures 3.14 to 3.16.

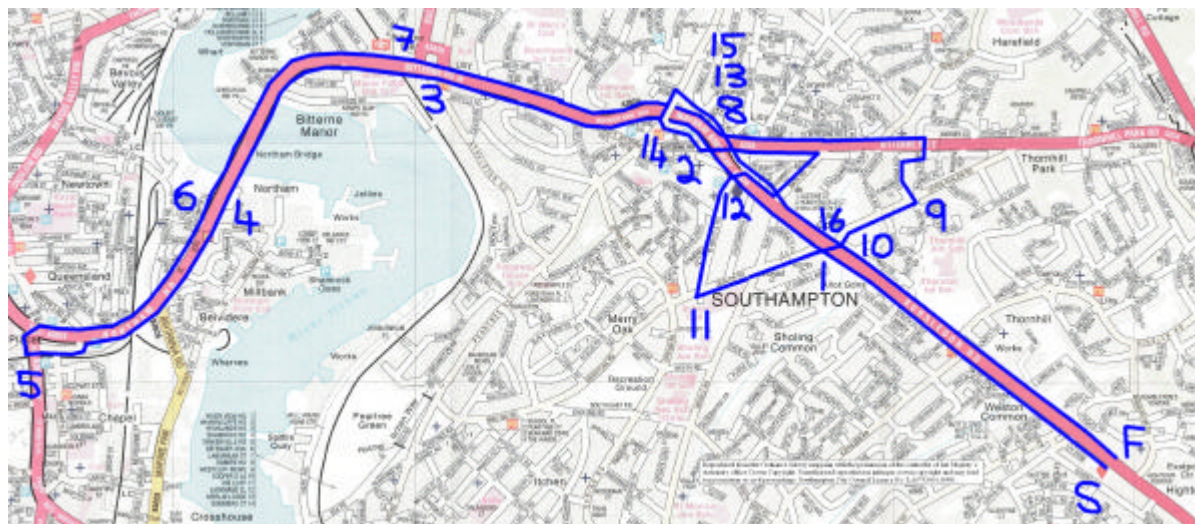

Figure 3.14 Floating Car Route Southampton Bitterne Main Route

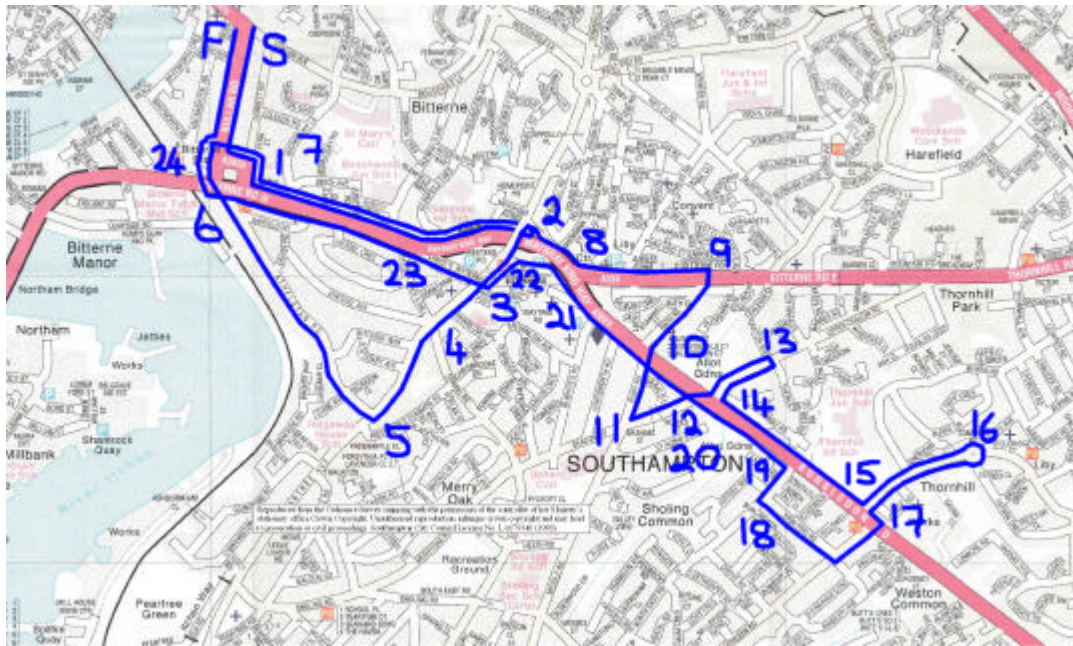

Figure 3.15 Floating Car Route Southampton Bitterne Side Roads

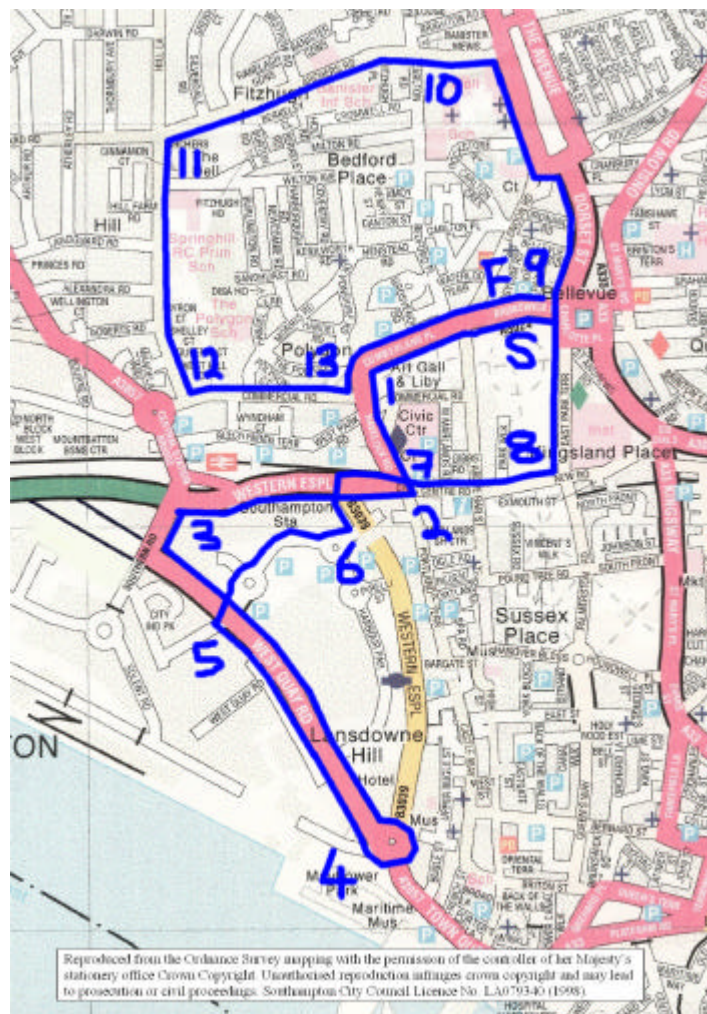

Figure 3.16 Floating Car Route Southampton City Centre



Bitterne Route

Figure 3.17 shows the average weekday a.m. peak journey times for each of the SCOOT and TUC system scenarios and route section (i.e., the links connecting each Checkpoint) on the Bitterne arterial route. The total journey time (in seconds) along the whole route, which is shown in the key to the right of the graph, is reduced under TUC by an impressive 30% compared to SCOOT. The measured benefits must be tempered against the fact that there were only three route sections where substantial improvements occurred. These were: start point to Checkpoints 1, 10 and 13. All of these sections used gating during the a.m. peak period when the signals were controlled by SCOOT, to deliberately restrict access. However, it should be noted that the congestion caused by gating traffic on the outskirts of the network far outweighed the resulting benefits along the arterial route approach to the City Centre, where only Checkpoint 3 fared significantly worse in TUC conditions.

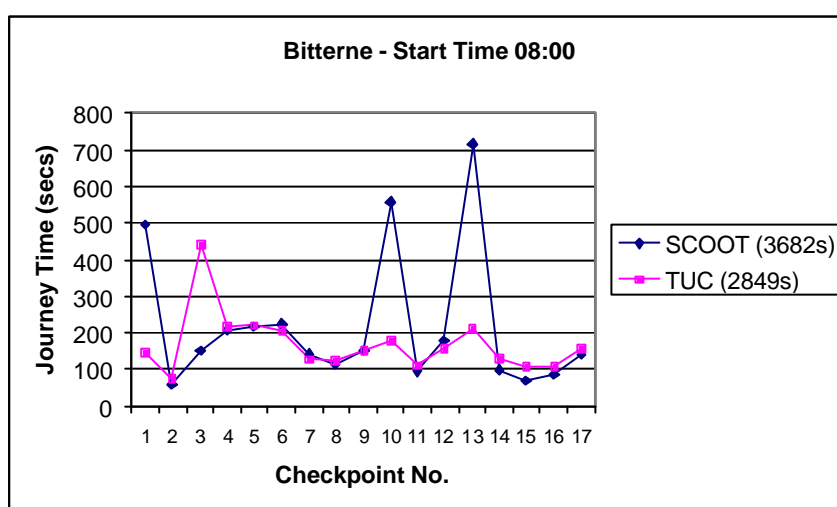

Figure 3.17 Average Journey Times on Bitterne Route during Weekday a.m. peak

The journey times were then factored according to the average flow on each route section and the results re-plotted in Figure 3.18. This factoring reduced the benefit under TUC to 8%, because the flow was particularly large on the route section (between Checkpoint 2 and 3) where SCOOT performed better, while flows were lower on the three route sections where TUC performed best.

However, it should be noted that such factoring by flows, although being a valid exercise, does not necessarily provide a ‘truer’ picture of what happened in the network. In the example of the Bitterne a.m. peak, the additional vehicles closer to the city centre, particularly in the critical-for-TUC section 3, have turned into the main route from the side streets during a different part of the cycle and have therefore, at least in the first part of their journey on the main route, experienced very different travel times from the floating cars altogether. Because of such in-turning traffic, the average travel times will be different from that of the floating cars in every single section of the route, and it is simply not known whether they are higher or lower.

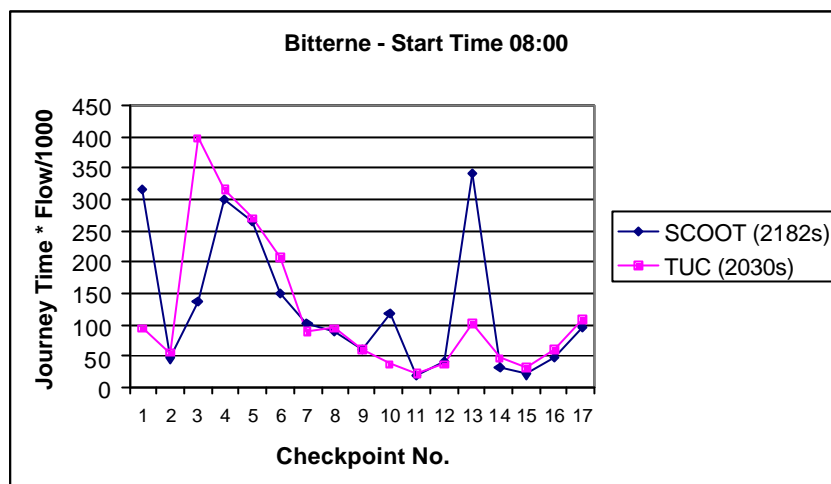

Figure 3.18 Average Journey Times (Factored by Flow) on Bitterne Route during Weekday a.m. peak

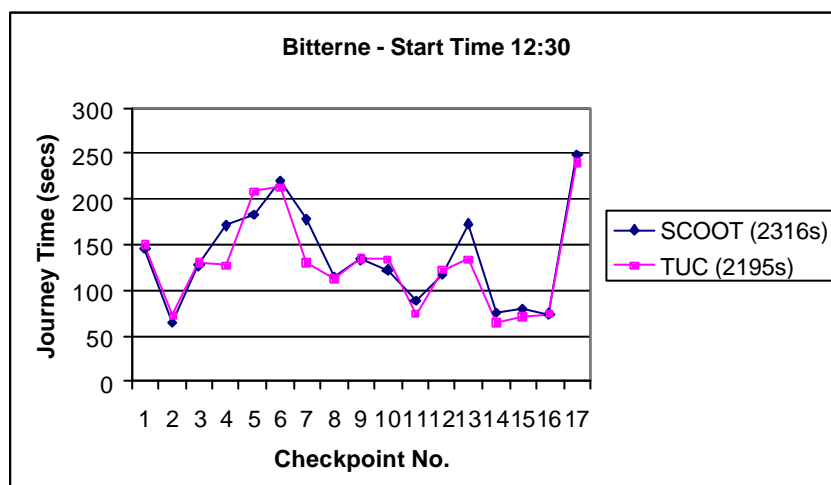

Figure 3.19 Average Journey Times on Bitterne Route during Weekday off-peak

Figure 3.19 shows the average journey times for the SCOOT and TUC systems during the off-peak. The findings were very consistent between the two UTC system scenarios, but the overall route journey time reduced by about 5% under TUC. When the results are factored by flow again this does not, in this case, change the overall picture, since the magnitude of improvement in journey time under TUC conditions remains about 5%.

Figure 3.20 shows the results of the floating car surveys undertaken during the p.m. peak in Bitterne. In this case, TUC again achieved a 5% improvement compared with SCOOT, mainly attributable to the journey times recorded on one route section (Checkpoint 5 to 6). Factoring by flow did not change the picture much apart from Checkpoint 6, where the difference became even more pronounced due to the relatively high traffic flow on this section. This had an implication for the overall route journey time, which now reduced by nearly 10% under TUC, compared with SCOOT.

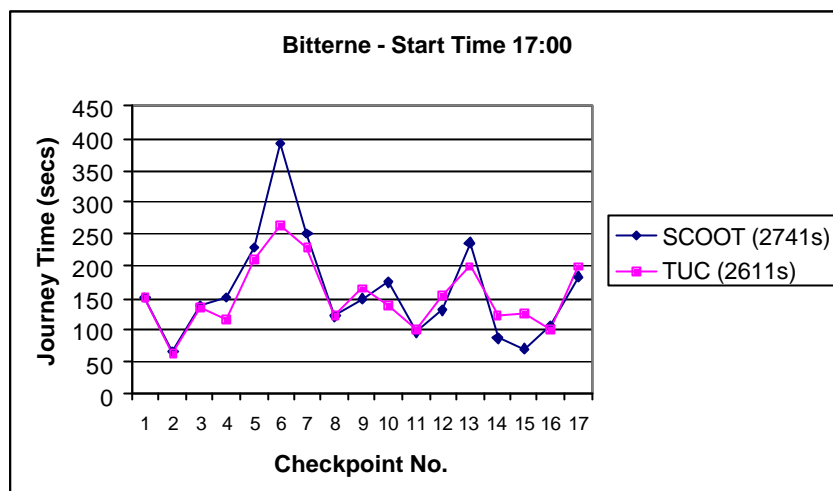

Figure 3.20 Demonstration Phase 2: Average Journey Times on Bitterne Route during Weekday p.m. peak

Bitterne Side Roads Route

An additional survey route was devised for the Bitterne area in the second demonstration phase, with the main emphasis given to the side roads. This convoluted route is certainly much less typical for real journeys in the area than the main route, but it was used to identify how far benefits under TUC for the main route were offset by disbenefits experienced by traffic turning into or crossing the main route. It should be noted that data for this route was only collected during one week of SCOOT operation and one week of TUC. After filtering out any ‘abnormal’ data, the data was averaged for each checkpoint and UTC system scenario and plotted for each time interval. Figure 3.21 shows the average weekday a.m. peak journey times on this route for each control scenario, where the overall route journey time under TUC increased by about 10% compared to SCOOT. This is the opposite finding to that found for the Bitterne main roads and confirms the assumption that some of the benefits given by TUC to the main route were at the expense of the more minor side roads. In contrast to the Bitterne main route, where differences between TUC and SCOOT concentrate on a few road sections, with many others showing no difference between the two systems, on the side route the differences between the two systems are more frequent. Three route sections show major benefits under SCOOT and two sections show major benefits under TUC. Factoring according to the average flow on each route section had the effect of increasing the magnitude in the difference in overall route journey time to about 15%.

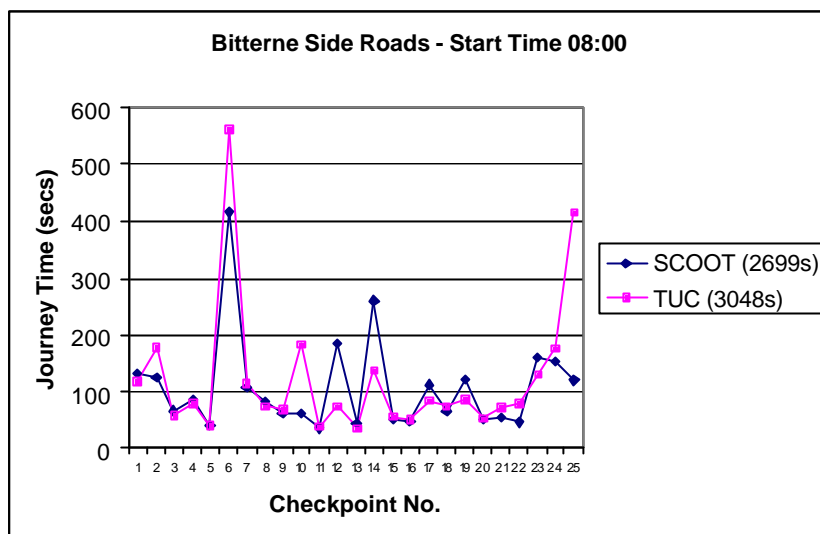

Figure 3.21 Average Journey Times on Bitterne Side Roads Route during Weekday a.m. Peak

Figure 3.22 shows the results during the p.m. peak along the Bitterne Side Road Route. As during the morning peak, there was evidence that the overall route journey time reduced in SCOOT conditions, compared with TUC, in this case by about 10%. However, the overall picture was even more disparate than in the morning, with now six sections showing major benefits under SCOOT and four sections showing major improvements under TUC. In this case, factoring with flow reduced the overall benefit for SCOOT from 10% to 4%

The journey times were then factored according to flow and this showed that the difference in the overall route journey time was much smaller, with a reduction of only about 4% under SCOOT, compared with TUC. Again it appears that TUC gives less emphasis to the side roads, but the resulting benefits to the main arterial route outweigh the disbenefits caused to the side road traffic.

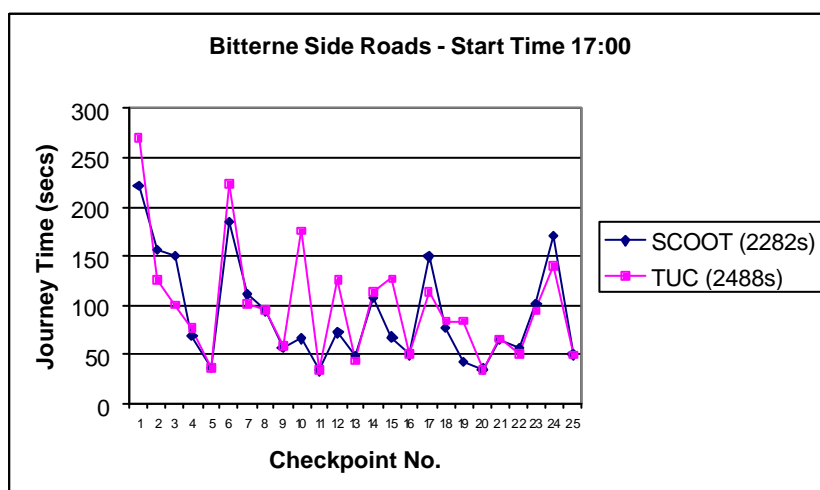

Figure 3.22 Average Journey Times on Bitterne Side Roads Route during Weekday p.m. peak



City Centre Route

For the City Centre Route, data was collected during two weeks of SCOOT operation and two weeks of TUC. After filtering out any data thought to be adversely affected by external events such as system faults, roadworks and incidents, the data was averaged for each checkpoint and UTC system scenario, and plotted for each time interval.

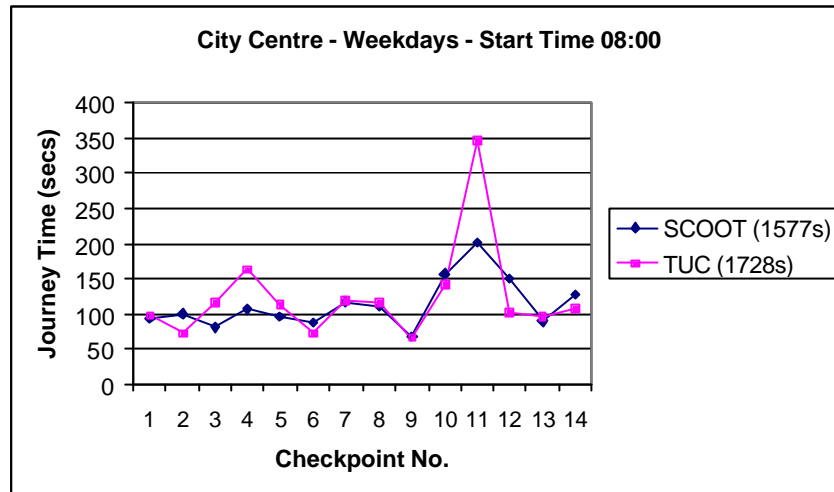

Figure 3.23 Average Journey Times on Southampton City Centre Route during Weekday a.m. Peak

Figure 3.23 shows the average weekday a.m. peak journey times, which have increased under TUC by about 10% compared to SCOOT. The route sections where SCOOT outperformed TUC were Checkpoints 4 and 11. When the journey times were factored according to the average flow on each route section, they still showed the same 10% reduction in journey time under SCOOT, and the same two main route sections where SCOOT outperformed TUC.

Figure 3.24 shows the results for the p.m. peak. The average overall route journey time reduced by about 20% under SCOOT compared with TUC. As in the morning, the main route sections where SCOOT outperformed TUC were Checkpoint 4 and 11, but in the afternoon Checkpoints 7 and 8 also did better under SCOOT. Factoring by flow does not change the overall figures.

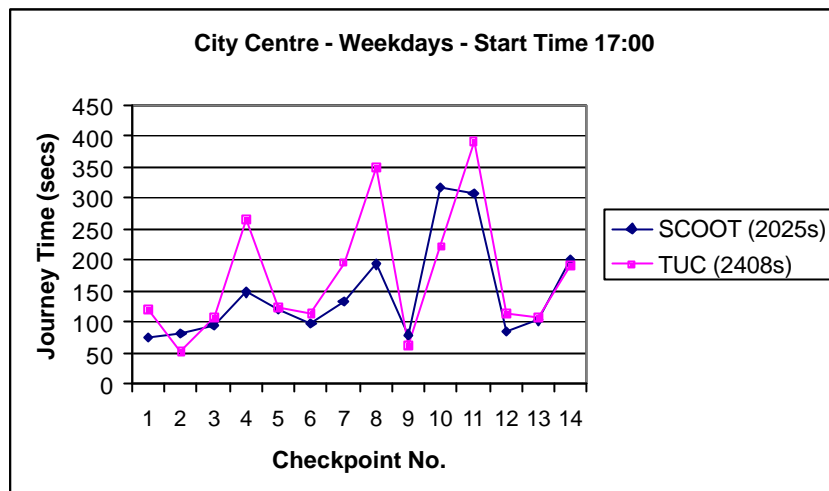

Figure 3.24 Average Journey Times on Southampton City Centre Route during Weekday p.m. Peak

Munich

On each of the 10 days during weeks 3 and 4 of the demonstration, six floating car trips were started to evaluate BALANCE and the hybrid. During week 3 BALANCE was running and in week 4 the hybrid (BALANCE + TUC). The route driven is shown in Figure 3.25. Links 1 to 14 are combined to Route 1 of the tour, 15-21 to Route 2 and 22-30 to Route 3.

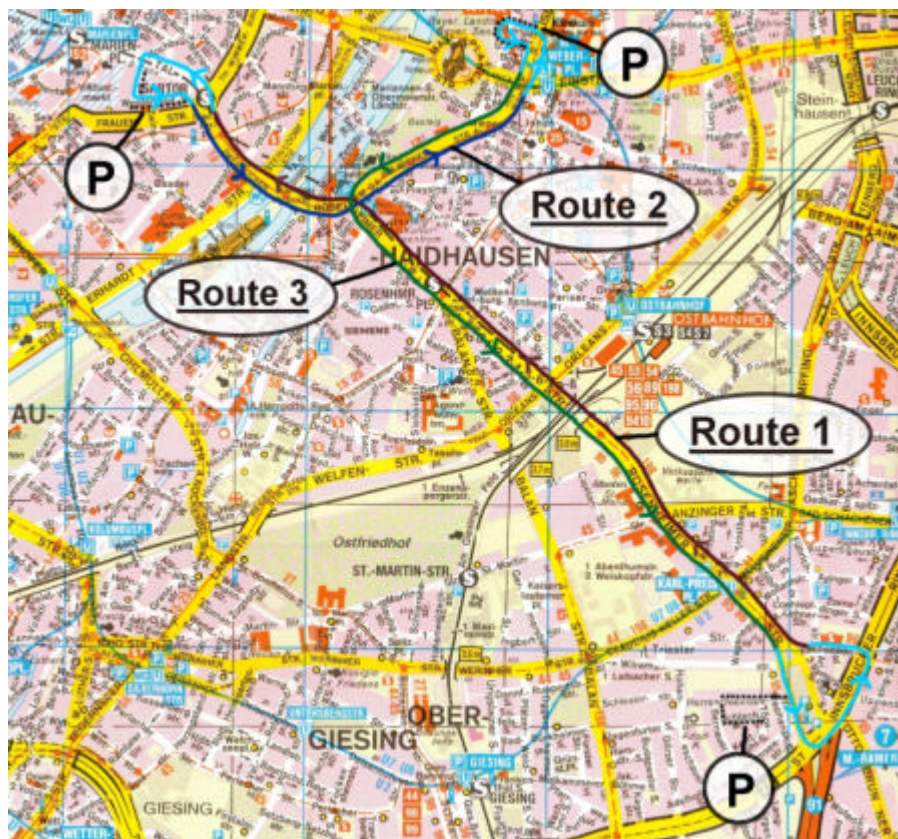

Figure 3.25 Floating Car Route Munich

Figure 3.26 shows the average journey times for the cars starting at 07:00 and 08:30. In the case of the first trip (07:00), trips of all five days could be evaluated. The chart for the 08:30 trips averages the two trips on Thursday and Friday. The lack of data on some links (2, 3, 4, 6 ...) corresponds with missing values in the charts.

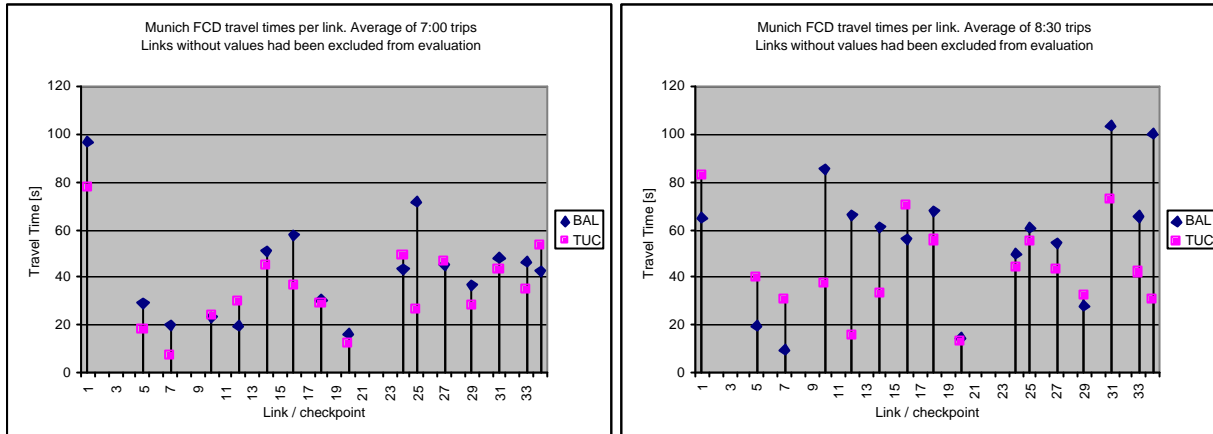

Figure 3.26 Average FCD Journey Times for Cars Starting at 07:00 and 08:30 (Munich)

Figure 3.27 shows the total travel time per route, sorted by the start time of the FCD cars. It shows graphically that major differences occurred only on Route 1 (into the city) during the trips starting at 08:30, 09:00 and 09:30. When this was investigated in detail, some problems were found that are independent of the control scenario and that could explain at least part of the differences:

- On one of the links there was one single trip under BALANCE scenario with a travel time of 128 s, while the average value for BALANCE would be just 60 s without this particular trip. Reasons why this one trip showed such a difference could not be found on the basis of the existing information.
- The trips starting at 08:30, 09:00 and 09:30 have a sample size of two each for BALANCE and TUC, so even though the differences look quite big, they are based on only two FCD trips each.

Table 3.12 shows all route travel times aggregated by route, trip and day pair. The trip number corresponds to the starting times 07:00, 07:30, 08:00, 08:30, 09:00, 09:30. This table gives an impression of how many trips and routes had to be excluded from the evaluation. At the right side of the table the sample size per route and trip is given; most of the measurements starting at 08:00 or later (trip ≥ 3) have a sample size of only two trips.

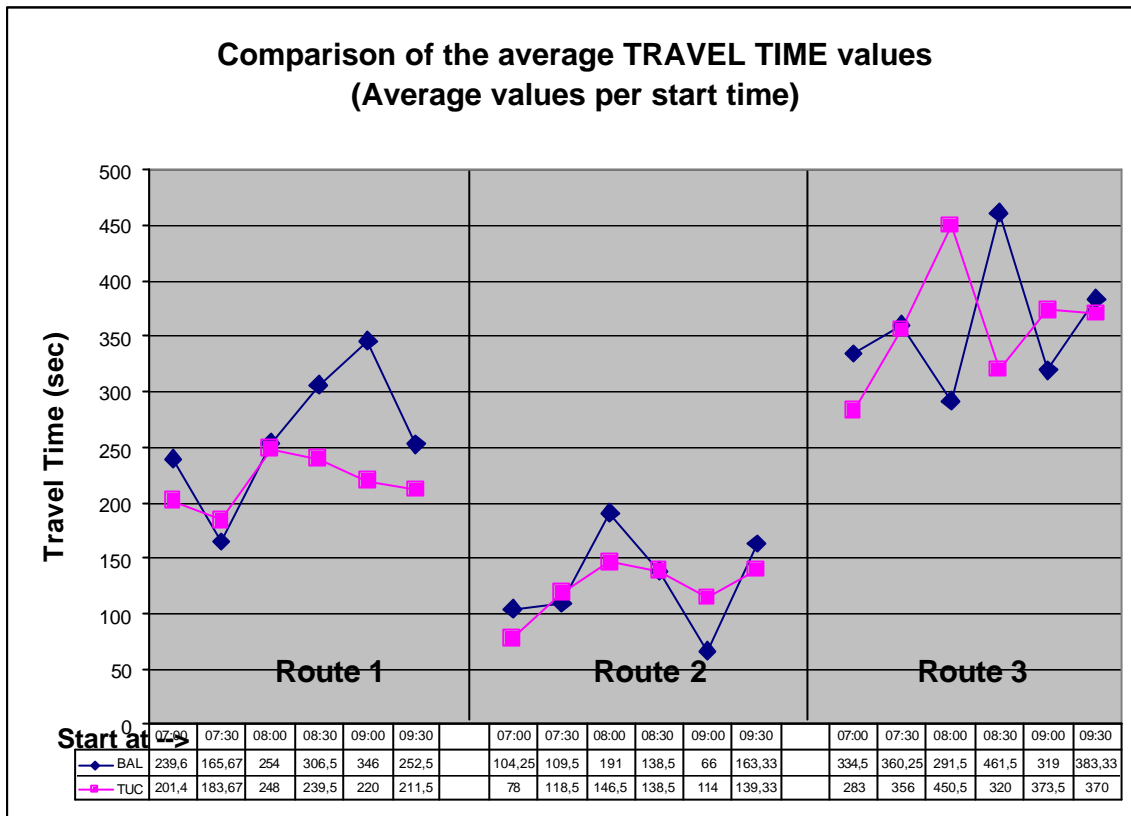

Figure 3.27 Averaged Travel Time Values for each Route and Start Time (Munich)

Table 3.12 FCD Travel Times Aggregated by Routes (Munich)

Summe - TT		DayPair		Scenario		1		2		3		4		5		Sample size					
Trip	Route	BAL	TUC	BAL	TUC	BAL	TUC	BAL	TUC	BAL	TUC	BAL	TUC	BAL	TUC	BAL	TUC				
1	1	180	192	274	198	219	189	362	203	163	255	5	5								
	2	112	59											432	248	275	354	364	388	4	4
	3	267	242																		
2	1	132	138	184	190	181	223	91	48	88	119	3	3								
	2	172	165											373	377	385	353	338	385	4	4
	3	344	309																		
3	1							251	227	277	289	2	2								
	2													317	89	65	204	2	2		
	3																				
4	1							285	237	327	242	2	2								
	2													148	174	129	103	2	2		
	3																				
5	1							428	329	495	311	2	2								
	2													429	198	263	242	2	2		
	3																				
6	1			127	188			228	270	277	153	2	2								
	2													101	114	262	136	3	3		
	3																				

Like Figure 3.27, Table 3.12 also shows the strong variance of values. It is thought that this is mainly caused by local public transport prioritisation, which changes green times very radically. A second effect is probably the position of the FCD car within the platoons, sometimes giving them good co-ordination due to their position in the platoon, and sometimes not.

Table 3.13 shows the average travel times for the three routes, calculated as simple average over all route specific values. As expected in the light of Figure 3.27, TUC shows lower journey times for Route 1 into the city.



Table 3.13 Summarized Travel Time Values for FCD Data (Munich)

TRAVEL TIME	Route 1	Route 2	Route 3	Total
Sample size	16	17	17	16.7
BALANCE	251	126	357	734
BAL+TUC	212	118	350	680
Diff. (abs.)	-39	-8	-7	-53
Diff. %	-15.4	-6.3	-2.0	-7.3

To analyse the variation of travel times, a statistical evaluation of the significance of the FCD data was applied. No significant differences between the travel times could be found for either of the three routes at a confidence level of 0.95 (95%). Only by reducing the confidence threshold to 90%, a significant improvement for TUC on Route 1 appeared to be probable, while no statistically significant difference at any reasonable confidence level could be found for Routes 2 and 3.

3.4 Fuel Consumption

Methodology

The calculation of fuel consumption uses a simplified version of the formula used within METACOR. With this formula, fuel consumption is derived from traffic volumes and mean traffic speeds from UTC system data, as well as the link length.

$$FC = \begin{cases} q \times L \times \left(4.49 + \frac{122}{v} + 0.0016(v - 60)^2 \right) & \text{if } v > 60 \\ q \times L \times \left(4.49 + \frac{122}{v} \right) & \text{if } v \leq 60 \end{cases}$$

where

- q is the traffic volume (in veh/h) in the link,
- v is the mean speed (in km/h) of the vehicles in the link, and
- L is the length of the link.

Chania

The average hourly fuel consumption corresponding to the TASS and TUC is shown in Figures 3.28 (Region 1) and 3.29 (Region 2). These figures show the per cent difference in fuel consumption for the two systems for the whole final demonstration phase.

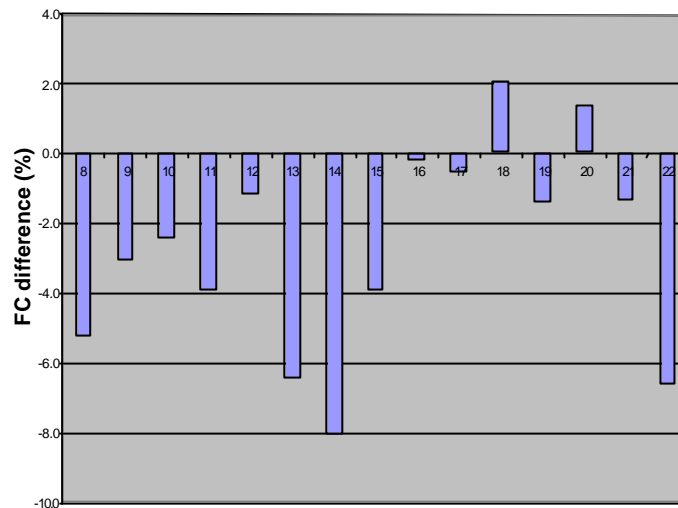

Figure 3.28 Average Fuel Consumption Difference (%) per Hour (Chania Region 1)

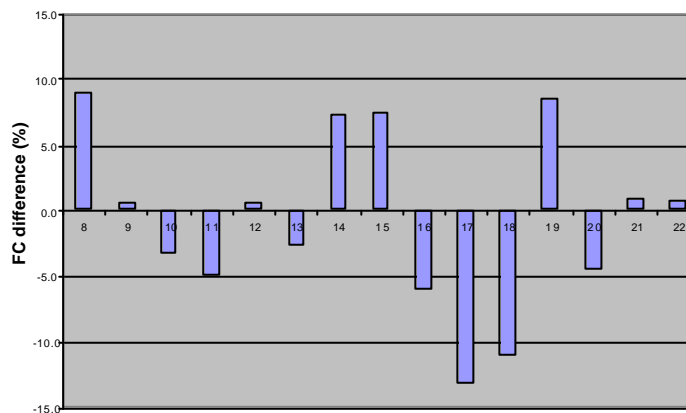

Figure 3.29 Average Fuel Consumption Difference (%) per Hour (Chania Region 2)

A general conclusion is that the implementation of TUC had a positive impact on fuel consumption, achieving a total decrease of 2.8% of fuel consumption for Region 1, while in Region 2 the total decrease was 0.6%. It is worth noting that, while TASS slightly outperforms TUC on the time-intervals 17:00-18:00 and 20:00-21:00 for Region 1, the fuel consumption at these time-intervals is lower for TUC which means that TUC, in this network, favours links where more fuel is being consumed.

Southampton

Table 3.14 compares the estimated fuel consumption (measured in vehicle litres) in the two regions for each time interval and UTC system.



Table 3.14 Comparison of Fuel Consumption in Southampton

Region	System	Weekdays			Saturdays
		08:00-09:00	12:00-13:00	17:00-18:00	11:00-12:00
Bitterne	SCOOT	891	700	837	769
	TUC	870	702	835	607
City Centre	SCOOT	1106	968	1086	1027
	TUC	1085	950	1080	916

For Bitterne, the fuel consumption under each system was extremely consistent during the weekday off-peak and p.m. peak periods. The increased fuel consumption under SCOOT during the weekday a.m. peak was largely attributable to the poor performance (relative to TUC) on the bnger, gated links on the outskirts of Bitterne. The lower figures for TUC on Saturdays have to be seen in the context of the much lower traffic volumes for that particular hour: the difference in the table above is 27%, while the difference comes down to 18% if the traffic volumes are taken into account; but this is still a remarkable achievement.

In view of the previously ‘poor’ performance of TUC compared with SCOOT in the City Centre Region, it is remarkable that the estimated fuel consumption was lower in the TUC scenario for all time intervals considered. Although the differences were small (about 1% – 2% in the weekday time intervals), this implies that the links where TUC outperformed SCOOT were longer than the links on which SCOOT fared better. It implies furthermore, that the overall picture for TUC in the City Centre would probably have been significantly better if harmonic speeds had been calculated for Southampton, as had been done later in the two other sites.

Munich

Table 3.15 presents the hourly aggregated values for fuel consumption for the various time-of-day-periods for all links that were valid for evaluation in the Munich test site. Fuel consumption values show comparable results during weeks 1/2, though not on first glance during weeks 3/4. However, during the latter set of weeks higher flows (+ 4% to + 4.5%) were measured under TUC which brings the fuel consumption, which also increased by 4.3% fully under TUC, for both systems fully back into line. Calculations based only on links valid for all four weeks show virtually no overall change for either set of weeks or the overall total.

Table 3.15 Summary for Fuel Consumption in Munich

FuelCons [l] for each time-of-day period										
Sum FuelCon [l]	Weekday 07:45 to 08:45		Weekday 07:30 to 10:00		Weekday 10:30 to 13:30		Weekday 16:00 to 19:00		Weekday 08:00 to 19:00	
	BAL	BAL TUC	BAL	BAL TUC	BAL	BAL TUC	BAL	BAL TUC	BAL	BAL TUC
Comparison of Week 1 and 2										
Total	603,1	609,5	605,2	611,4	515,7	517,5	694,9	704,3	592,8	598,1
% diff.	1,1%		1,0%		0,3%		1,4%		0,9%	
Comparison of Week 3 and 4										
Total	424,7	457,2	412,8	448,1	401,3	398,8	562,3	592,8	456,5	476,0
% diff.	7,6%		8,6%		-0,6%		5,4%		4,3%	
Average of ALL weeks (average of weeks 1/2 and weeks 3/4)										
Total	513,9	533,3	509,0	529,8	458,5	458,1	628,6	648,5	524,7	537,1
% diff.	3,8%		4,1%		-0,1%		3,2%		2,4%	



3.5 Emissions

Methodology

The calculation of emissions is, as the calculation of fuel consumption, based on UTC system data for mean traffic speed. To calculate the average emissions per vehicles (in g/km), a simple formula was used:

$$EF = (a \cdot v^2 + b \cdot v + c) / v \text{ [g/km]}$$

where

- v is the mean speed (in km/h) of the vehicles, and
- a, b and c are factors for the different emissions as given in the following table:

Emission factors	Parameter		
	a	b	c
HC	-0,003588	0,641291	22,63632
CO	-0,007506	2,61822	180,562
CO2	-0,266369	116,2025	2940,474
NOx	-0,000268	1,494679	-3,060485
mKr	-0,115157	40,47425	1008,319

Results

Tables 3.16 to 3.19 show the results of the calculations for emissions in Chania, the two Southampton areas and Munich. Since they are based on the same data as the fuel calculations, it is not surprising that the two sets of results are well in line.

For Chania, it is clear that, in Region 1, TUC has a slightly better emission performance than TASS, while both systems have a similar emission performance in Region 2.

For Bitterne, the estimated weekday values appear to be generally well-balanced between the two UTC systems with no evidence of any real differences between the two sets of data. As before, the Saturday results were derived with higher flows under SCOOT and should not be attributed solely to the UTC system in operation at the time. For Southampton City Centre, the weekday values were, as the fuel values, generally well balanced between SCOOT and TUC and do not really reflect the differences in mean speeds and travel times in the City Centre.

For Munich, any differences between the amounts of emissions for the two systems could be explained by differences in flow in the same way as for fuel. Equally, figures that were only calculated on the basis of links that provided data for the full four weeks, did not change the picture in any way.



Table 3.16 Comparison of Emissions in Chania

Emission type	Region 1		Region 2	
	TUC	TASS	TUC	TASS
HC	43.22	44.12	37.54	37.65
CO	308.64	315.68	264.08	264.93
CO2	6177.18	6292.51	5446.56	5460.52
NOx	19.32	19.20	20.06	20.05
mKr	2123.95	2163.60	1872.58	1877.39

Table 3.17 Comparison of Emissions in Southampton Bitterne

Emission Factor	UTC System	Weekdays			Saturdays
		08:00-09:00	12:00-13:00	17:00-18:00	11:00-12:00
HC	SCOOT	67.8	61.9	66.1	61.7
	TUC	64.4	63.2	66.8	59.2
CO	SCOOT	453	404	434	404
	TUC	425	413	439	385
CO2	SCOOT	10626	10071	10590	10002
	TUC	10185	10236	10672	9692
Nox	SCOOT	64.1	71.0	70.5	69.4
	TUC	64.6	70.8	70.4	69.7
MKr	SCOOT	3640	3444	3625	3420
	TUC	3489	3501	3653	3312

Table 3.18 Comparison of Emissions in Southampton City Centre

Emission Factor	UTC System	Weekdays			Saturdays
		08:00-09:00	12:00-13:00	17:00-18:00	11:00-12:00
HC	SCOOT	127	126	132	138
	TUC	131	126	135	122
CO	SCOOT	833	830	873	922
	TUC	864	829	896	803
CO2	SCOOT	20207	20154	20874	21549
	TUC	20720	20137	21262	19563
Nox	SCOOT	132	133	132	128
	TUC	132	133	131	130
MKr	SCOOT	6919	6900	7151	7386
	TUC	7097	6894	7286	6696



Table 3.19 Comparison of Emissions in Munich

HC [g] for each time-of-day period										
Sum HC [g]	Weekday 07:45 to 09:45		Weekday 07:00 to 10:00		Weekday 10:30 to 13:30		Weekday 16:00 to 19:00		Weekday 08:00 to 19:00	
	BAL	BAL TUC	BAL	BAL TUC	BAL	BAL TUC	BAL	BAL TUC	BAL	BAL TUC
Comparison of Week 1 and 2										
Total	10,023,4	10,133,3	10,073,6	10,189,3	8,515,4	8,524,6	11,554,8	11,721,6	9,823,4	9,910,4
% diff.	1,1%		1,1%		0,1%		1,4%		0,9%	
Comparison of Week 3 and 4										
Total	6,979,0	7,537,9	6,771,4	7,390,9	6,545,4	6,533,2	9,251,6	9,782,3	7,488,4	7,832,9
% diff.	8,0%		9,1%		-0,2%		5,7%		4,6%	
Average of ALL weeks (average of weeks 1/2 and weeks 3/4)										
Total	8,501,2	8,835,6	8,422,5	8,790,1	7,530,4	7,528,9	10,403,2	10,751,9	8,655,9	8,871,7
% diff.	3,9%		4,4%		0,0%		3,4%		2,5%	

CO [g] for each time-of-day period										
Sum CO [g]	Weekday 07:45 to 09:45		Weekday 07:00 to 10:00		Weekday 10:30 to 13:30		Weekday 16:00 to 19:00		Weekday 08:00 to 19:00	
	BAL	BAL TUC	BAL	BAL TUC	BAL	BAL TUC	BAL	BAL TUC	BAL	BAL TUC
Comparison of Week 1 and 2										
Total	70,397,8	71,100,3	70,847,7	71,619,0	59,528,5	59,455,4	81,317,4	82,403,5	68,873,9	69,395,7
% diff.	1,0%		1,1%		-0,1%		1,3%		0,8%	
Comparison of Week 3 and 4										
Total	48,467,5	52,467,3	46,910,5	51,478,7	45,221,1	45,268,4	64,327,3	68,153,1	51,915,3	54,447,2
% diff.	8,3%		9,7%		0,1%		5,9%		4,9%	
Average of ALL weeks (average of weeks 1/2 and weeks 3/4)										
Total	59,432,6	61,783,8	58,879,1	61,548,8	52,374,8	52,361,9	72,822,3	75,278,3	60,394,6	61,921,5
% diff.	4,0%		4,5%		0,0%		3,4%		2,5%	

CO2 [g] for each time-of-day period										
Sum CO2 [g]	Weekday 07:45 to 09:45		Weekday 07:00 to 10:00		Weekday 10:30 to 13:30		Weekday 16:00 to 19:00		Weekday 08:00 to 19:00	
	BAL	BAL TUC	BAL	BAL TUC	BAL	BAL TUC	BAL	BAL TUC	BAL	BAL TUC
Comparison of Week 1 and 2										
Total	1,468,476,9	1,484,603,3	1,473,793,7	1,489,615,8	1,255,360,3	1,259,626,2	1,691,510,1	1,715,483,3	1,443,295,8	1,456,723,0
% diff.	1,1%		1,1%		0,3%		1,4%		0,9%	
Comparison of Week 3 and 4										
Total	1,034,301,5	1,113,676,0	1,005,410,1	1,091,536,7	977,464,5	971,734,5	1,369,963,5	1,444,603,2	1,112,384,7	1,160,084,8
% diff.	7,7%		8,6%		-0,6%		5,4%		4,3%	
Average of ALL weeks (average of weeks 1/2 and weeks 3/4)										
Total	1,251,389,2	1,299,139,6	1,239,601,9	1,290,576,3	1,116,412,4	1,115,680,3	1,530,736,8	1,580,043,3	1,277,840,2	1,308,403,9
% diff.	3,8%		4,1%		-0,1%		3,2%		2,4%	

Nox [g] for each time-of-day period										
Sum NOx [g]	Weekday 07:45 to 09:45		Weekday 07:00 to 10:00		Weekday 10:30 to 13:30		Weekday 16:00 to 19:00		Weekday 08:00 to 19:00	
	BAL	BAL TUC	BAL	BAL TUC	BAL	BAL TUC	BAL	BAL TUC	BAL	BAL TUC
Comparison of Week 1 and 2										
Total	5,765,3	5,849,0	5,712,6	5,761,1	5,183,1	5,304,8	6,563,9	6,672,0	5,792,6	5,886,1
% diff.	1,5%		0,8%		2,3%		1,6%		1,6%	
Comparison of Week 3 and 4										
Total	4,483,0	4,717,2	4,432,1	4,604,2	4,466,4	4,317,4	5,889,9	6,084,9	4,903,4	4,996,2
% diff.	5,2%		3,9%		-3,3%		3,3%		1,9%	
Average of ALL weeks (average of weeks 1/2 and weeks 3/4)										
Total	5,124,2	5,283,1	5,072,3	5,182,6	4,824,8	4,811,1	6,226,9	6,378,5	5,348,0	5,441,2
% diff.	3,1%		2,2%		-0,3%		2,4%		1,7%	

MKr [g] for each time-of-day period										
Sum MKr [g]	Weekday 07:45 to 09:45		Weekday 07:00 to 10:00		Weekday 10:30 to 13:30		Weekday 16:00 to 19:00		Weekday 08:00 to 19:00	
	BAL	BAL TUC	BAL	BAL TUC	BAL	BAL TUC	BAL	BAL TUC	BAL	BAL TUC
Comparison of Week 1 and 2										
Total	504,389,7	509,980,8	506,222,5	511,733,0	431,095,4	432,551,1	590,925,8	589,243,3	495,671,5	500,324,6
% diff.	1,1%		1,1%		0,3%		1,4%		0,9%	
Comparison of Week 3 and 4										
Total	355,214,3	382,518,7	345,306,0	374,904,8	335,586,4	333,671,7	470,480,6	496,164,8	382,000,2	398,408,2
% diff.	7,7%		8,6%		-0,6%		5,5%		4,3%	
Average of ALL weeks (average of weeks 1/2 and weeks 3/4)										
Total	429,802,0	446,249,8	426,764,2	443,318,9	383,340,9	383,111,4	526,703,2	542,704,1	438,835,8	449,366,4
% diff.	3,8%		4,1%		-0,1%		3,2%		2,4%	



4 Comparative Evaluation of User Acceptance

4.1 Introduction

In the assessment of the user acceptance of TUC, users are defined as highway authorities and traffic control operators. The basis for this assessment was questionnaire that was filled in by the operators. The questionnaire, that was the same for operators in each of the three SMART NEST sites, contained 9 questions:

- Questions 1 to 6 relate to the initial implementation of the TUC system, and attempt to assess the costs of implementation of TUC compared to the costs of implementing a comparable UTC system.
- Questions 7 to 9 relate to the ongoing operation and maintenance of the TUC system.

The full questionnaires and responses can be found in the appendices of deliverables D18, D19 and D20. Chapters 4.2.1 to 4.2.9 below describe the responses from each site to each question in the User Acceptance Questionnaire. Each question asks the system operator to compare TUC against the base case of UTC control: TASS in Chania, SCOOT in Southampton, and BALANCE in Munich.

4.2 Results of User Acceptance Questionnaires

4.2.1 Data Requirements

In Chania data requirements for TUC are lower than for TASS, in Southampton data requirements are greater for TUC than for SCOOT, and in Munich the data requirements of TUC and BALANCE are approximately equal.

In Chania, TASS and TUC require very similar types and amounts of data both for off-line design of the control strategy and for on-line operation. The main off-line data both systems need are junction staging, length and number of links and lanes and detector distance from the stop-line. Additional off-line data needed by TUC (e.g., turning rates, saturation flows, link capacities) have, in Chania, been based on rough estimations and calculations and no major effort has been involved in gathering this data.

TASS in Chania is based on the selection between six different fixed-time plans, selected every 10 minutes based on detector occupancy and flow measurements, which can then be locally modified by the local controllers through extension of green times. The design and fine-tuning of these fixed-time plans has required substantial effort. In contrast, TUC uses one simple fixed-time program as a starting point, which is then modified in real-time; furthermore, TUC does not need the construction of fixed-time offsets, since it calculates the offset in real-time. The fine-tuning of TUC took approximately four to five months and much less effort than the TASS fine-tuning. The Chania operators believe that neither system requires further major readjustment of the control parameters once the system performance has reached an acceptable level.

For the on-line operation, both systems require the collection and processing of the data measured by loop detectors roughly every cycle, and the same type of data are transferred



from the local detectors to the central system in both systems. TUC gets data from 68 detectors, while TASS only uses data from 28 detectors located at strategic links of the network; however, TASS requires in the Chania implementation another 32 detectors that are used by the local controllers for stage extensions, bringing the total number of detectors used by TASS close to that for TUC. Half of the detectors used by TUC are TASS detectors, located at different distances from the stop-line; while those detectors that were specifically installed for TUC are located in the middle of the link.

Overall, the costs incurred for gathering and analysing the data for developing the strategy and for fine-tuning are much higher for TASS than TUC, while the costs incurred by all other data requirements are approximately the same for both systems.

In Southampton both systems require similar amounts, and similar levels, of data. Both systems require detectors, preferably in every link. Most of the data for both systems can be gathered with similar effort and cost. However, TUC requires turning rates for every approach to a junction for different day types and different times of day. The Southampton operators decided that using estimates would disadvantage TUC, and the subsequent acquisition of this data was more costly than any other data requirement. Six-hour traffic counts were performed at nine junctions, while the remaining turning count data was taken from a traffic-flow survey undertaken by Southampton University in 1993. Even these limited surveys cost around €5,300 and it took three weeks to arrange for, and complete, the work.

Once TUC became operational, it was found that a number of locations had significant variations in turning rates over the day, and that the use of fixed turning rates prevented TUC from responding adequately. Subsequently, all of the turning links that had detection for approaching vehicles were adjusted to operate using these detectors, which improved the systems' response to changing traffic flows.

However, where turning links do not have separate detection, SCOOT is able to use data from so-called "historic loops", i.e., traffic volumes that passed in the previous cycle over downstream detectors during the relevant upstream green time. TUC does not possess this facility and has therefore currently higher requirements for specific turning detectors than SCOOT for optimal performance, which could make a new site installation or an installation in an existing UTC site marginally more expensive.

In Munich, in general, all data required by TUC is available within the BALANCE system. The main supply data required for TUC are the network definition, signal control data and static traffic data. All network definition data (links with number of lanes, length and capacity, detector position) required by TUC are comparable to the BALANCE network attributes. Of the required signal control data some is directly available within the BALANCE supply data (cycle implemented times), and some can be derived from other control data attributes (relations stages to links, green/intergreen times, constraints). Similarly, some parts of the traffic data used by TUC are common with the supply data of BALANCE (e.g. saturation flow), while others can be determined by output of BALANCE, if TUC is used as a hybrid implementation with BALANCE (turning rates, exit rates,) or is additional if its implemented as a stand-alone system. On the other hand BALANCE also needs some data, which is not required by TUC. Overall, the effort involved in collecting traffic data is comparable for both systems.



Of the dynamic data required by TUC, everything is available within a UTC system that is able to run BALANCE. Overall, the data requirements for both BALANCE and TUC are quite modest in comparison with other network control systems and are more or less comparable. All supply data TUC needs is available directly within a BALANCE control environment or can be derived easily. The level of detail of the required data is also comparable for both systems. Therefore there is no additional effort for data supply with the base case (BALANCE without TUC), if suitable data transformation functions are implemented.

4.2.2 Requirements for data transmission

In Chania and in Munich the requirements for data transmission are the same for TUC and for the base case of UTC control, while in Southampton the data transmission requirements are theoretically lower for TUC.

In Chania, both TUC and TASS require the transmission of measurement data and control decisions once every cycle and, in both cases, conventional modems of similar architecture/capabilities are used for data transmission. Both TASS and TUC modems communicate through underground private wire cables that have been installed over the past six years for TASS. Since the difference in cost was very small, more cables than strictly necessary for TASS had been installed, and therefore no major effort has been involved in connecting the additional TUC modems.

The existing SCOOT system in Southampton includes a very efficient data communications element, which exceeds the requirements of the TUC system. Frequency of communication for SCOOT is once per second, while TUC normally only requires communication once per cycle; instant reporting would only be required for a bus priority module. However, the Southampton operators require a permanently open data line, mainly to allow for instant reporting of local controller faults and communications failures, and would therefore choose not to take advantage of TUC's lesser communication requirements.

Southampton City Centre is catered for by private wire circuits, which means that the amount of communication transmitted does not affect costs. The remainder of the city is, however, connected via rented British Telecom lines. The BT costs are in the region of €1,250 per site for 24 hours a day, 365 days a year, communications. To replace this with a dial-up service would introduce an increased opportunity for communication failure with more hardware and software involved, and communication would have to be initiated many times per day. Furthermore, any problems occurring at the intersection would not be reported instantaneously to the control centre. The cost of a BT dial-up connection in Southampton would be the high with a 4.9p connection charge for every call initiated, or over €9,000 per year per site, much higher than for a permanent line.

As an alternative, GPRS communication, which is virtually real time, could be used for both TUC and SCOOT. GPRS has higher set-up costs, but significantly lower operating costs. The operators estimate an average cost of €6,000 to install and €6,000 per year line rental per region, depending on the locations involved. TUC would probably not need to transmit more than 1 Mb per week, which at €8 for the first Mb and €1.50 for each subsequent Mb per month would equate to €160 per year per site. The amounts of data transmitted by



SCOOT would be several Mb per week, but at just €1.50 for each additional Mb, the costs for SCOOT would still be very low.

In Munich TUC and BALANCE use similar control and traffic data from field devices with the same level of detail and the same transmission frequency. Therefore they have comparable requirements concerning the data transmission, and the costs for communication is the same. The city is the owner of the communication system between the local controllers and the control centre. In general, cables and modems are depreciated and therefore there are nearly no variable costs for data transmission.

4.2.3 Requirements for local controllers

The requirements for local controllers in Southampton and Munich are approximately equal for TUC and the base case UTC systems, while in Chania the local controller requirements are lower for TUC than for TASS.

In the TASS version running in Chania, local controllers modify the fixed-time plan selected by the central controller, based on flow/occupancy measurements taken every second from the loop-detectors of the junctions' ingoing links; green-time extension is usually given to links with high occupancy or flow. Thus, the TASS local (MASMO) controllers require some 'intelligence' for collecting, filtering and processing the measurements and calculating local control decisions. In TUC, the local controllers only implement the central controller's control decisions. Therefore, although both systems are now using the same local controllers, TUC does not make use of the "intelligence" of the TASS local controllers, and thus it could run with controllers that have less power and speed capabilities and would therefore be less expensive.

In Southampton, both SCOOT and TUC allow a 'window' for the local controller to run a stage. The local controller decides on the phases used in that stage, but the duration of the stage is dictated by the operating system. Operating this way lessens the amount of data transfer to and from the central processor, and lowers the workload of the central processor. The main benefit occurs in a communication failure situation when the local controller retains sufficient intelligence to behave in an acceptable and safe manner. The specification and cost for a local controller in Southampton should be similar for both systems. The approximate cost of a local controller capable of operating a large junction is €12,000.

Intersection controllers in Munich run vehicle-actuated controls for public transport priority and therefore need a suitable amount of computational power, local detectors, etc. An implementation of a network control can be based on the functionality, which already exists at the local layer (e.g., local detector measurements). What needs to be added is an interface to the control centre for uploading data (controller status, detector measurements) and downloading the control parameters. This interface had already been implemented for BALANCE and did not need to be modified for the implementation of TUC. Therefore, the requirements for the local controllers are also the same for TUC and BALANCE.

4.2.4 Requirements of central data processing

In all three sites the requirements of central data processing are approximately equal for TUC when compared against the base UTC systems.



In Chania neither TASS nor TUC requires expensive or fast data processing; in both systems a conventional PC is used for calculating the control commands, running without any problems. The costs of the central control system are roughly the same in both systems.

In Southampton a central controller is essential. Via this controller each node in the system operates in partnership with adjoining nodes, producing a much more efficient road network than could otherwise be achieved. Therefore both systems require a central controller, which would be very similar for the basic functionality of both systems. Both SCOOT and TUC can run on a PC but in the Southampton system the central controller is an HP Alpha, which is sufficiently intelligent to run the SCOOT algorithm, while TUC was installed on a separate PC.

In Munich, both systems only need a central controller with a modest amount of computational performance. Both BALANCE and TUC are able to control an area like the SMART NETS demonstration site with a normal industrial PC and no specific hardware is necessary. Within the Munich system architecture for traffic control systems each centre consists of at least three PC's: one for the communication with the field devices, one for the distributed database engine and at least one PC for the applications (e.g., TUC or BALANCE). The costs per PC are about €12K.

4.2.5 Interoperability with existing systems

In Chania the creation of a TUC-TASS interface introduced extra effort for the TUC implementation, in Southampton an interface was not necessary, while in Munich the hybrid implementation of TUC with BALANCE meant that interoperability was not an issue.

In Chania, a special software interface was developed by Siemens Greece for the purposes of SMART NETS for interfacing the TUC software with the central control system. The difficulties and problems encountered in this task were mainly due to the fact that this was the first time such an interface had been developed and tested. A new PC that runs the TUC and Siemens Greece interface bypasses TASS's MIGRA computer. However, the MIGRA computer monitors the operation of all local controllers in order to ensure the safe and correct operation of the system, as well as to inform the operator regarding any failures or other problems in the operation of the system.

In Southampton both SCOOT and TUC were written in the same programming language, which made it relatively straightforward to utilise the existing system as a base for TUC. The interface between the systems and the interaction between TUC and the base system are considered to be "excellent" by the operators. If TUC had required to be implemented in a basic UTC environment, where SCOOT did not already operate as it did in Southampton, the operators assume that the resulting effort for developing interfaces would have been substantial. They believe that costs for creating an interface for TUC would be similar to the costs for creating the SCOOT interface, as both systems require the same data input from UTC and supply the same control output to UTC.

In Munich the TUC system has been integrated by GEVAS software into the BALANCE system (hybrid control). Therefore the interface has been implemented within the software. Both BALANCE and TUC are written in C++, so the implementation of the interfaces caused



no severe problems, although software development, testing etc. involved some effort. Without BALANCE as an implementation base the effort would be greater because interfaces to the local controllers, to the supply database etc., would have had to be implemented in addition.

4.2.6 Ease of implementation

In Chania and Southampton the operators believe that the implementation of TUC required no more effort than the implementation of their base systems. In Munich the operators believe that a TUC implementation would require marginally greater effort than a BALANCE implementation.

In Chania the main effort involved in the TUC implementation was the interfacing with the current system. Overall, compared with the initial implementation of TASS and, in particular the subsequent fine-tuning, the TUC implementation in Chania was relatively straightforward.

In Southampton once TUC was installed, all of the relevant data collected, and the database modified, there was little effort in implementing either SCOOT or TUC in their respective regions. The TUC implementation required three description files and a control matrix for each region and this task was carried out in SMART NETS by TUCrete. The Southampton operators regard the provision of a good operator interface for this as essential to protect against inexperience or inadvertent errors, if TUC becomes commercially available. The data in the description files is similar to the data that can be adjusted on-line in SCOOT while, again, there is no operator interface in TUC yet that would allow any such on-line adjustment.

In Munich the implementation of a network control causes creates costs even if the control algorithms (like TUC and BALANCE) have modest requirements for computational power and communication performance. For BALANCE some effort has been made to adapt the system as far as possible to the Munich control architecture. This means that most of the BALANCE supply data are produced automatically based on existing data (e.g., definition files of the local controllers) by the supply interfaces of the network control.

Because of the hybrid implementation of TUC, most of this integration work has also been used for TUC. Some additional planning steps were necessary for TUC implementation, e.g., the determination of the TUC control matrix. The automatic integration of these TUC specific supply steps has not been performed by the Munich partners within SMART NETS. The Munich operators, therefore, have no experience with this part of the implementation. Obviously, the actual TUC implementation causes a slightly higher effort than the implementation of BALANCE without TUC, but for a future implementation the remaining additional steps could and should also be integrated in a more or less automated supply, and therefore the additional effort is not regarded as a problem.

It needs to be noted that in Munich, because of the SMART NETS time-scale and the implementation delays in MOBINET, both BALANCE and TUC went from verification to the demonstration phase with a mere minimum of fine-tuning: just a few days for each system. Both systems performed well with this, but the Munich operators have no experience that



would allow them to compare the effort and possible benefit that would have been involved in fine-tuning either system further in the way this was done in Chania and Southampton.

4.2.7 Ease of use of TUC system

In Chania and Munich the TUC system was considered very easy to run, without requiring operator intervention. In Southampton the operators believe that TUC runs less well than SCOOT without intervention, and that the SCOOT system responds better to such intervention.

In Chania, once the systems are implemented and fine-tuned, both TUC and TASS can run without any further operator intervention.

In Southampton, the SCOOT system needs very little oversight or intervention. However, intervention does take place occasionally (on average twice per week), for example, when there are roadworks in the area effecting traffic flow at a node. The three parameters most commonly altered by the operators are: the minimum stage time, the maximum stage time and a value that relates to the number of traffic lanes for a particular approach. This is simply and quickly accomplished in SCOOT and can be undertaken using a 'trial and error' approach. This prompts SCOOT to react more quickly to a situation by narrowing its behaviour window. Without such intervention SCOOT would still have eventually resolved the situation itself, but in a less satisfactory time scale. TUC, in its current implementation in Southampton, has no such facilities and SCOOT is therefore, at least for the time being, much more flexible and easier to modify than TUC.

In Munich, very little supervision or intervention is expected by the system operator. This has been a basic user requirement, because there is no operator who is able to observe the network control systems continuously. Therefore, both TUC and BALANCE have to run in a stable manner without interventions. There was no monitoring of the system during the TUC field trials. Interventions become necessary if parts of the network or of the control equipment are modified; in this case the supply data also has to be adapted.

4.2.8 Need for readjustment of parameters

In Chania and in Munich the requirement for adjusting parameters is approximately equal for TUC and the base systems, while in Southampton the operators believe that TUC requires greater intervention and does not recover quickly after a parameter change.

The Chania control operators feel that, once TUC and TASS are running satisfactorily, very little further readjustment of parameters is needed.

The Southampton operators routinely closely monitor any new implementation under various traffic conditions, and fine-tune the parameters to optimise performance. This usually takes place within the first few hours, but can also be at various occasions over the next day or two. Readjustment will also be required in response to changes in traffic flow. This could be due to slow changes over time, or as a result of incidents on the road network. SCOOT has evolved over the years to be increasingly flexible in its control of traffic whilst retaining its core responsibilities and alterations can be made easily. None of these facilities are



currently available in TUC. If implemented in a real situation it is essential that many parameters are available for the user to configure on-line.

Database changes can also be undertaken in SCOOT fairly quickly, but would require a system restart to become effective. Following a restart SCOOT picks up from the most recent network and control state before the restart and therefore adapts to the current situation, with the new parameters in effect, very quickly. In TUC some parameters can be altered in the description files, and some would require a rebuild of the matrix. In either case, TUC also requires a restart to apply the changes. In contrast to SCOOT, TUC does not 'remember' the state it was in immediately prior to restart and instead uses default values (referred to as 'nominal settings'). Therefore, it requires more time to adjust to the present traffic flow situation than SCOOT.

In Munich, the implementations both of TUC and BALANCE are quite recent, so it wasn't necessary to re-adjust the implemented systems. Therefore, the operators have no experience about the requirements concerning readjustment. Their expectation is that, apart from the adjustment of supply data in the case of changes in the network or the control equipment, the following readjustments will be needed: BALANCE will require adjustment of the reference-OD-matrix every one or two years and, at some point, the weight factors of the performance index; TUC will require, at some stage, adjustment of the control-matrix and the importance factors. These parameters can be easily adapted, but the operators envisage a general problem, which is the difficulty to determine whether and when the actual parameter sets are not optimal. Any severe problems, such as serious recurrent congestion, are easy to detect but for less obvious mis-adjustments a more sophisticated strategy, such as an automatic quality assurance tool, is considered desirable.

4.2.9 Ease of adding or removing intersections to/from network

In Chania it is considered easier to make additions or remove a junction from the network with the new TUC system, while in Southampton and Munich the effort required is similar for TUC and for the base systems.

In Chania the addition of a new junction that has not previously run under TASS or TUC requires the same effort in both systems for installing and testing the hardware equipment needed for the addition. However, for changes in the strategy design the effort needed by TASS is substantially higher, since all six fixed-time programs have to be modified by incorporating the new junction(s). The control parameters for the real-time selection of the fixed-time strategy are global parameters for the whole network, so these have to be appropriately redefined and fine-tuned: the addition of one or more junctions may require the modification of all or most of these control parameters unless the new junctions are isolated or far from the ones already run under TASS.

For TUC, the initial design needed for incorporating the new junction(s) requires the addition of the parameters describing the geometry, staging, turning rates and location of detectors to the TUC input files, which is not a major task. The TUC control parameters that will need to be modified and fine-tuned will mainly affect only the new junction and probably its direct neighbours.



Removing or adding an intersection does not require major additions/changes to the software and the communication system in either system. In both, the user interface allows the operator to easily remove or add one or more junctions from/to the list of junctions that operate under TASS or TUC by simply clicking on the corresponding junction(s). Whenever the operator initiates such a change, the corresponding software interface takes all the appropriate actions in such a way that the change does not cause abrupt changes in signal timings. However, if the removal of a junction is initiated for a longer time period, the operator would have to seek the assistance of TUCrete for amending the control matrix and the input data set to maintain optimal system performance.

In Southampton, adding an intersection to either SCOOT or TUC requires a certain amount of hardware, and a data communication facility to the site. The basic data is entered into the database, and there may also be changes to neighbouring junctions. Once the system is updated, the intersection is monitored under various traffic conditions and fine-tuning takes place. In SCOOT this usually involves on-line changes of certain parameters, while under TUC changes cannot currently be made on-line. In the Southampton implementation, the removal of a junction in TUC would involve deleting the appropriate data from the files and rebuilding the matrix. The new matrix and data files then have to be applied to the system. Although the work required for removing a junction is very different for the two systems, it is similar in amount and complexity.

In Munich, the addition of intersections to the BALANCE control is integrated in a supply process which is – because of the hybrid implementation of TUC – also used for TUC. For both BALANCE and TUC some planning steps are necessary, which might be partly automated in the future. Overall the addition, removal or modification of intersections is not a large effort with either system. Concerning hardware, the inclusion of a new intersection requires a local intersection controller and a communication line to it.

Concerning the effort for additional fine-tuning there is, as mentioned before, little experience with TUC in Munich. The operators have the impression that fine-tuning may be more important for the operation of TUC than for BALANCE, since the latter determines some parameters automatically through measurements, but there is no clear evidence to support this assumption.

4.2.10 Conclusion

Overall, user acceptance in Chania is very high. The operators feel that TUC is an excellent strategy, providing the system operator with a high degree of flexibility and tools to achieve the desired performance. The operators believe that, with careful fine-tuning, TUC can show a very efficient performance. The Municipality will continue to use both TASS and TUC in their traffic network, and intends to continue working with the Technical University of Crete to further improve and evolve TUC.

In Southampton, user acceptance of TUC suffered somewhat from the lack of an operator interface and the resulting need to seek support from the TUCrete when any changes to the system had to be made; many facilities, both operational and functional, that have been built into SCOOT over the years are still missing in TUC. Nevertheless, the operators feel that it was a remarkable achievement for an entirely new system like TUC to perform as well as it did, and to stand up so well against a system like SCOOT that has been improved and



optimised over many years. If TUC had shown an improvement over SCOOT under saturated traffic conditions in the impact assessment, they would have wished to continue using it during peak hours after the close of SMART NETS, as long as they had been provided with a better user interface. Under the current circumstances, Southampton City Council will observe further TUC developments and implementation with a close interest in order to decide whether a TUC implementation in Southampton should be reconsidered at a later stage.

In Munich, TUC was only ever run as a BALANCE /TUC hybrid, and the Munich operators have therefore no direct experience with TUC as a stand-alone system. As an add-on to BALANCE, user acceptance of TUC in Munich was high, and KVR would have supported further implementations of the hybrid in the city if the impact assessment had shown that TUC could improve significantly on BALANCE. In the current circumstances KVR will watch any further development of TUC and results of future TUC implementations, in order to decide whether another TUC hybrid, or even a TUC stand-alone system, should be installed in Munich at a later stage.



5 Socio-Economic Assessment

5.1 Introduction

The socio-economic assessment is concerned with the cost-effectiveness of implementing and operating TUC. The evaluation plan envisaged a comprehensive consideration of all cost elements, but only a partial consideration of some of the main potential benefits.

The cost factors to be taken into account are the costs of implementation, operation and maintenance of the systems. For this socio-economic assessment a comparison of these costs between the TUC system and the reference systems is extracted from the responses given by the system operator in the User Acceptance Questionnaire. None of the three TUC implementations took place in a 'greenfield' site: in all three sites advanced UTC systems were already in place, and the TUC implementation took advantage of the existing infrastructure and control and communication software. In Chania, the operator who assessed TUC has gone through a comprehensive TASS 'from scratch' implementation in recent years, and could therefore directly compare the effort involved in installing and fine-tuning the two systems. In Southampton, SCOOT had been in both test sites for many years, and had only undergone upgrades in more recent times. In Munich, both TUC and BALANCE were practically installed at the same time but here the comparison between TUC and BALANCE was complicated by the fact that TUC was only implemented as a hybrid version with BALANCE, and therefore it has been difficult for the operators to identify exactly what would be the requirements for a stand-alone TUC system.

On the benefit side, indicative time savings and VOCs attributable to TUC and the reference systems were estimated on the basis of the speeds and travel times for the second demonstration phase that are described in more detail in chapter 3. Both the value of time savings and the calculation of VOCs was based on the EWS, the German guidelines for socio-economic assessment.

5.2 Results of Socio-Economic Assessment

5.2.1 Costs for Implementation, Operation and Maintenance

Implementation

Implementation costs for a new TUC installation (or installation of any other UTC system) will include the costs of acquiring and installing the software, of installing required controllers, communications links, etc.

Overall, the effort of implementing TUC in Chania was quite straightforward, when compared to a TASS implementation. The main effort of the TUC implementation was the development of the new interface between TUC and existing systems. For data requirements and for local controller requirements TUC costs are lower than for TASS, while for data transmission and for central data processing costs for TUC and TASS are approximately equal.



For interoperability with existing systems a special software interface was developed in SMART NETS for interfacing the TUC software with the central control system. The development of this software was a major task, due to the fact that this was the first time such an interface was developed and tested.

Overall, the costs incurred for gathering and analysing the data for developing the strategy and for fine-tuning are much higher for TASS than TUC, due to the substantial efforts required to fine-tune the six fixed-time plans TASS is selecting from. Requirements for local controllers are actually less for TUC. TUC and TASS both use the same controllers, but since TUC does not make use of the “intelligence” of the TASS local controllers, it could run with controllers that have less power and speed capabilities and would therefore be less expensive. The costs of data transmission between the local controllers and the control centre are the same for both systems. No further costs have been incurred for data transmission for the newly-installed TUC system as existing TASS cables were used. The costs of the central control system and central data processing are roughly the same in both systems in Chania.

For TUC and for SCOOT in Southampton most of the costs associated with implementation, such as the requirements for local controllers, the requirements for central data processing, the ease of software implementation and requirements for interfaces for interoperability with existing systems, are comparable. There is, however, a difference between the two systems in the data requirements and the requirements for data transmission. For data requirements at the time of system implementation TUC has a cost associated with obtaining turning count data. An up-front cost of €5,300, for surveys of turning movements, was incurred in the TUC implementation in Southampton, that would not have been necessary for a SCOOT implementation.

For data transmission requirements, the frequency of communication for SCOOT is once per second, while TUC normally only requires communication once per cycle; instant reporting would only be required for a bus priority module. However, the Southampton operators require a permanently open data line, mainly to allow for instant reporting of local controller faults and communications failures, and would therefore not want to take advantage of TUC’s lesser communication requirements. The installation of a dedicated communication network, as SCOOT has in the City Centre will incur very substantial set-up costs, while a British Telecoms connection, as SCOOT has in Bitterne, and would be suitable for TUC in either area has very low set-up costs. The option of GPRS communication would cause higher initial set-up costs for both systems, but for TUC even more so than for SCOOT.

For data requirements the costs for TUC and BALANCE in Munich are comparable. Some data are required by both systems, while some data are required just by BALANCE, or just by TUC, so that the requirements and costs even out. Similarly for data transmission, the requirements for BALANCE and TUC are comparable and there are no additional costs for TUC.

Requirements for local controllers are the same for TUC and for BALANCE. In fact the requirements for local controllers in Munich are determined by the computational needs of public transport priority. For central data processing both TUC and BALANCE have modest computational requirements that can be met by normal industrial PC’s. Interoperability with BALANCE has not been an issue since TUC has been integrated into BALANCE in order to run



as a hybrid version. If this integration had not occurred there would have been extra costs associated with TUC for the implementation of interfaces between the systems.

For overall implementation, some additional steps have been necessary for TUC, that are not needed for BALANCE. For example, an off-line control matrix has to be calculated for TUC, giving TUC a small extra cost.

Operation Costs

In Chania, operation costs are the same for both systems since TUC and TASS can both run without operator intervention, after they have been implemented and fine-tuning completed.

In Southampton, operation costs are also, in most respects, the same for both systems. One possible difference relates to the ease of use of the TUC system. The Southampton operators believe that SCOOT is more flexible and easier to modify than TUC, essentially due to the lack of a user interface in the TUC Southampton implementation.

The main potential difference in operation cost comes, as for the set-up costs, from the communication system. However, these costs are inverse: the most expensive set-up of a dedicated communication network, would run virtually without any costs, GPRS would incur very low running costs, with those for TUC even lower than for SCOOT. Permanently open BT lines are considerably more costly (around €1,250 per site per year), while for a dial-up connection, the structure of the BT charging system, with a minimum charge for each call initiated, would make running TUC with €9,000 per site prohibitively expensive. Conversely, in countries, where telephone charges are made solely per time unit used, TUC would only incur a fraction of the charges caused by SCOOT.

Operation costs are the same for both systems in Munich since TUC and BALANCE can both run without operator intervention, after they have been implemented and minimal fine-tuning has been completed.

Maintenance Costs

The user acceptance questionnaires addressed two issues that are potentially relevant in this context:

- Need for readjustment of parameters
- Ease of adding or removing intersections to/from network

In Chania, adjustment of parameters requires the same effort under the TUC or TASS systems. The operators in Chania have found that under both systems very little readjustment of parameters has been required after implementation.

Similarly adding or removing a junction to the network, in most aspects, requires the same effort for TUC and for TASS, although with TASS there is a greater effort in making changes to the strategy design for the six fixed-time signal programs.

In Southampton, maintenance is required for both hardware and software. Concerning hardware, there are no differences between SCOOT and TUC, since they use the same



central controller, the same local controllers and the same detectors. With regard to software, adjustment of parameters is somewhat more straightforward in SCOOT, as many parameters can be adjusted on-line, with immediate effect – a facility that is not available in TUC due to the current lack of a user interface. Off-line database or matrix alterations can equally be undertaken for SCOOT and TUC. Turning rates required by TUC may have to be re-adjusted in case of major changes. This could make the effort for maintaining TUC marginally higher.

Adding or removing an intersection from the network can be done for both SCOOT and TUC with moderate effort. Although the work required for removing a junction is very different for the two systems, it is similar in amount and complexity.

In Munich, the actual requirements for adjustment of parameters are slightly different for TUC and BALANCE although the overall effort required is similar. Similarly, adding or removing a junction to the network requires the same effort for TUC and for BALANCE, although the exact steps to be taken within each system are a little different.

Overall Costs

A comparison of the overall costs of implementation, operation and maintenance between TUC and the base systems in Chania, Southampton and Munich is summarised in Table 5.1.

Table 5.1 Comparison of Overall Costs

	Chania	Southampton	Munich
Implementation Costs			
Data Requirements	TUC costs lower	TUC costs higher	Approx. equal costs
Requirements for data transmission	Approx. equal costs	TUC costs lower	Approx. equal costs
Requirements for local controllers	TUC costs lower	Approx. equal costs	Approx. equal costs
Requirements of central data processing	Approx. equal costs	Approx. equal costs	Approx. equal costs
Interoperability with existing systems	TUC costs higher	Approx. equal costs	N/A (hybrid system implemented)
Ease of implementation	Approx. equal costs	Approx. equal costs	TUC costs marginally higher
Operation Costs	Approx. equal costs	TUC costs higher	Approx. equal costs
Maintenance Costs			
Need for readjustment of parameters	Approx. equal costs	TUC costs higher	Approx. equal costs
Ease of adding or removing intersections to/from network	TUC costs lower	Approx. equal costs	Approx. equal costs



In Chania, for TUC there has been a higher cost associated with the development of the interface between TUC and the existing Chania control systems. This cost is at least balanced, and quite likely outweighed, by the higher costs associated with TASS – for data requirements and local controllers, and for the fine-tuning and implementation (and any required adjustments) of the of the six TASS fixed-time plans.

Overall, the implementation costs in Southampton are, in principle, roughly the same for both systems. Any differences depend much more on the choice of the communication system, and to a lesser extent on the question whether the operator feels that he needs special surveys to determine typical turning rates. Operation costs are potentially slightly higher for TUC, as are the costs associated with adjustment of parameters.

In Munich, for TUC and BALANCE the implementation costs as well as operation and maintenance costs are very similar.

5.2.2 Time Savings

There are two possible sources of data to calculate time savings: the journey time surveys with floating cars and the speed measurements from the UTC system. Unfortunately they do not only show a different magnitude of improvements, but in many cases even a different direction for some times of the day. Furthermore, the times for the floating car runs have been chosen to represent some particularly critical times during the week, and not to be representative for the whole day. Therefore, for time savings (and for Vehicle Operating Costs) there are no firm conclusions, and only an indicative range of figures can be provided.

The value of time has been set at €10/h.

Chania

The first range of estimates can be made on the basis of measured journey times, as shown in Table 5.2. Since there is no indication of journey times during the a.m. peak or in other off-peak periods of the day, no daily averages can be calculated. Therefore, each of the total cost figures provided in Table 5.2 is to be read as “if this journey time change were representative for the whole region AND for every hour from 08:00 to 23:00.” These costs therefore merely represent a range of figures that indicate how much weight such time savings carry in the socio-economic assessment. Because the figures range from €–1828 per day to €+ 931 per day, no definite conclusions can be drawn whether there would be a clear net benefit for TUC in the East Entrance Region. In contrast to that, the benefits for the City Centre range from €+630 per day as the lowest figure to €+21,152 per day as the highest, and it is therefore safe to say that there will be a very significant net benefit in this region. Even based on the lowest of these figures the annual total savings would far outweigh any possible investment, operation and maintenance costs in a UTC system in a short time period, even if started from scratch and not introduced as an alternative to an existing TASS system.



Table 5.2 Time Savings based on Measured Journey Times in Chania

East Entrance				
	Journey time [s]		Difference	
	TUC	TASS	Time [s]	Total cost [€/d]
Tuesday noon	160	159	-1	-53
Tuesday evening	162	136	-26	-1828
Wednesday noon	153	128	-25	-1761
Wednesday evening	124	112	-13	-879
Thursday evening	129	142	13	931
Saturday afternoon	122	133	11	773
City Centre				
	Journey time [s]		Difference	
	TUC	TASS	Time [s]	Total cost [€/d]
Tuesday noon	1477	1577	100	3436
Tuesday evening	2281	2657	377	13000
Wednesday noon	1796	2019	223	7708
Wednesday evening	1264	1282	18	630
Thursday evening	1772	1809	38	1303
Saturday afternoon	2542	3155	613	21152

Table 5.3 shows the second set of calculations for Chania, based on the speeds measured by the UTC system. This is, in spite of all shortcoming of UTC data, certainly more representative for the whole day than the floating car measurements, and the increase in the costs for time spent in the East Entrance is €74 per day with TUC. However, although the speed increase under TUC for the city is seemingly also rather small, with 0.3 km/h only three times larger than the decrease in the East, this carries much more financial weight because of the very much larger network that is involved:

- the 0.3km/h speed increase equates to
- a very significant decrease in cost for time spent in the network of €1,852 per day or
- for a six-day week, excluding Sundays, a staggering €578,000 per year.

Table 5.3 Time Savings based on UTC Speeds in Chania

08:00-23:00	Speed [km/h]		Difference	
	TUC	TASS	Speed [km/h]	Cost [€/d]
East	12.8	12.9	0.10	-74
City Centre	10.8	10.5	-0.30	1852

Southampton

Also for Southampton, time savings have been calculated both on the basis of floating car journey times and the speed measurements from the UTC system. Unfortunately they do not only show a different magnitude of improvements, but in the case of Bitterne even different directions: in the floating car measurements and the UTC speeds weighted with flow and link length, TUC fared overall better, but in the speeds only weighted with flow TUC fared



slightly worse than SCOOT. Therefore, for time savings (and for Vehicle Operating Costs) there are no firm conclusions, and only an indicative range of figures can be provided.

The first estimate can be made on the basis of measured journey times, as shown in Table 5.4. If the results for the main Bitterne route were typical for the whole area, this would mean a very significant net benefit for TUC in this region. The Bitterne side roads route, with its frequent turns from one side road into another, is certainly less typical for the overall network, but will carry some weight. Unfortunately, for the side road route there are no off-peak measurements, but it should be safe to assume that the overall floating car data for Bitterne would still provide a net benefit for TUC in this area, albeit not as large as Table 5.4 would indicate.

Table 5.4 Time Savings based on Measured Journey Times in Southampton

<i>Journey times as measured</i>				
Bitterne Route				
	Journey time [s]		Difference	
	SCOOT	TUC	Time	Total cost [€h]
Weekday AM peak	3682	2849	-833	-1712
Weekday off peak	2316	2195	-121	-186
Weekday PM peak	2741	2611	-130	-267
		<i>Total per 12h</i>		-5449
Bitterne Side Roads Route				
	Journey time [s]		Difference	
	SCOOT	TUC	Time	Total cost [€h]
Weekday AM peak	2699	3048	349	935
Weekday PM peak	2282	2488	206	552
		<i>Total for 4h</i>		2973
City Centre Route				
	Journey time [s]		Difference	
	SCOOT	TUC	Time	Total cost [€h]
Weekday AM peak	1577	1728	151	604
Weekday PM peak	2025	2408	383	1532
		<i>Total for 4h</i>		4272

For the City Centre, Table 5.4 shows a significant net benefit for SCOOT. The UTC data showed a much lower difference between speeds for TUC and SCOOT during the whole 12-hour day than for the peak periods, and TUC must therefore have done better than SCOOT during times of low flows. The total figure for time savings for the 12-hour day would therefore be lower than for the four-hour total, but it is impossible to say by how much.

Table 5.5 shows the same calculations, but based on the journey times factored by the traffic volumes in each section. This table shows the same general trends as Table 5.4, but much lower totals. How far the factoring brings the figures closer to representative values for the network is difficult to judge and, as mentioned above, and it certainly works against TUC for the Bitterne main route in the a.m. peak.



Table 5.5 Time Savings based on Measured Journey Times in Southampton (factored by flow)

<i>Journey times factored by flow</i>				
Bitterne Route				
	Journey time [s]		Difference	
	SCOOT	TUC	Time	Total cost [€]
Weekday AM peak	2182	2030	-152	-312
Weekday off peak	1410	1310	-100	-154
Weekday PM peak	2005	1834	-171	-351
		<i>Total per 12h</i>		-2560
Bitterne Side Roads Route				
	Journey time [s]		Difference	
	SCOOT	TUC	Time	Total cost [€]
Weekday AM peak	1040	1219	179	479
Weekday PM peak	1152	1194	42	113
		<i>Total for 4h</i>		1184
City Centre Route				
	Journey time [s]		Difference	
	SCOOT	TUC	Time	Total cost [€]
Weekday AM peak	999	1106	107	428
Weekday PM peak	1313	1555	242	968
		<i>Total for 4h</i>		2792

Table 5.6 Time Savings based on UTC Speeds in Southampton

07:00-19:00	Speeds factored by flow only				Speeds factored by flow and length			
	Speed [km/h]		Difference		Speed [km/h]		Difference	
	SCOOT	TUC	Speed [km/h]	Cost [€/d]	SCOOT	TUC	Speed [km/h]	Cost [€/d]
Bitterne	33.6	33.3	-0.23	222	32.4	33.5	1.10	-1095
City Centre	31.6	31.2	-0.40	439	31.3	31.0	-0.30	334

The third set of calculations can be based on the speeds measured by the UTC system. On this basis, there is still an increase in the costs for time spent in the City Centre for both types of factored speeds, albeit on a much smaller level (Table 5.6). For Bitterne, the results based on factoring by flow only show a small advantage for SCOOT, while with for the double factoring there is a much more significant benefit for TUC. It has been mentioned before that the factoring by length is somewhat dubious for Bitterne, but it is nevertheless remarkable that the results with the double factoring are roughly in line with those for the floating car data.

Munich

As was the case for Southampton, time savings calculated from FCD data not only show a different magnitude of improvements, but even a different direction from the UTC based results for two of the routes. Furthermore, the time for the floating car runs has been chosen to represent the particularly critical morning peak period, and not to represent the whole day.



Therefore, for time savings (and for Vehicle Operating Costs) there are no firm conclusions, and, again, only an indicative range of figures can be provided.

The first set of estimates can be made on the basis of measured journey times, as shown in Table 5.7.

Table 5.7 Time Savings based on Measured Journey Times in Munich

	Journey time [s]		Difference	
	TUC	BALANCE	Time [s]	Cost [€/3h]
Route 1	212	251	39	393
Route 2	118	126	8	91
Route 3	350	357	7	35
All 3 routes				519

The second set of calculations, based on the travel times estimated by the UTC system for the same routes, for which the floating car measurements were made, is shown in Table 5.8.

Table 5.8 Time Savings for FCD Routes Based on UTC Speeds in Munich

	Journey time [h]		Difference	
	TUC	BALANCE	Time [h]	Cost [€/3h]
Route 1	262.1	263.5	1.4	14
Route 2	163.9	150.4	-13.4	-134
Route 3	180.2	174.2	-6.0	-60
All 3 routes	606.1	588.1	-18.0	-180

WEEK 3 AND 4 ONLY

	Journey time [h]		Difference	
	TUC	BALANCE	Time [h]	Cost [€/3h]
Route 1	213.7	210.7	-3.0	-30
Route 2	158.0	139.5	-18.5	-185
Route 3	170.1	178.3	8.2	82
All 3 routes	541.8	528.5	-13.3	-133

The first part of the table shows the results for all four weeks, for which UTC data was collected, and the second part the UTC results only for those two weeks during which the FCD data was collected as well, to allow a direct comparison between the two sets.

As already discussed in chapter 3 before, there is a significant difference between the assessment for the same routes through FCD and UTC data during the same weeks: the costs for time from UTC data indicate a €133 /3h saving for BALANCE, while costs from FCD data indicate a €519 /3h saving for TUC. Since, again as already discussed in chapter 3, the UTC speeds are not directly measured but derived by BALANCE from measurements through a series of estimates, the directly measured floating car travel times are deemed to be more reliable, even if the floating car measurements also failed the significance test.



A comparison between the two parts of the table highlights again the aforementioned variability between the weeks, most notably for route 3, where there is a net benefit of €82 /3h for TUC in week 3 and 4 and of €60 /3h for BALANCE over all four weeks, with an underlying advantage of €202 /3h for BALANCE in week 1 and 2; this means a shift of €284 from -202 to +82 between weeks. Routes 1 and 2 show slightly smaller differences between the results for both sets of weeks (€88 and €102 /3h), although Route 1, as Route 3, shows a reversal between advantages for TUC and BALANCE. The fact that, overall, the UTC data indicates that TUC performed relatively better in week 2 than in week 4 would suggest that also the floating car measurements might have still been better than they were anyhow, which would make them even more impressive.

The underlying TTD for those parts of the three routes that could be included in the evaluation is 10,000 veh*km in total for those three hours; the TTD for the whole network is 20,000 veh*km. If it were to be assumed that the measured journey times and speeds were typical for the whole network then the possible total value of time savings, for this three-hour time period alone, would range from around €270,000 per year benefit for TUC on the basis of the FCD to a €90,000 per year benefit for BALANCE on the basis of the UTC data.

Since there is no indication of FCD journey times outside the morning peak, no daily averages can be calculated from this data, and only the less reliable and more variable UTC data is available.

Table 5.9 shows again a big difference between the two weeks, both in absolute journey times and in the time difference. It is mainly the latter that is of major concern since the difference in absolute terms can be explained to some extent by real differences between the two sets of weeks due to weather conditions, but mainly through the fact that different numbers of links were available for evaluation during the two sets of weeks. But the week to week variation cannot be explained through this, and the average is therefore not very meaningful. It would be more appropriate to consider the two sets of results of an annual benefit of €80,000 /11h for TUC and an annual benefit of €215,000 /11h for BALANCE as a possible range of results, and even that with some qualification.

Table 5.9 Time Savings based on UTC Speeds in Munich

	Journey time [h]		Difference	
	TUC	BALANCE	Time [h]	Cost [€/11h]
Week 1/2	3507	3537	30.1	301
Week 3/4	2706	2623	-82.5	-825
All 4 weeks	3106	3081	-25.7	-257

5.2.3 Vehicle Operating Costs

Benefits from reductions in Vehicle Operating Costs (VOCs) are always expected to be around ten times lower than the monetary benefits from time savings, and this was also the case in all three SMART NETS sites.

Since VOCs as well as time savings depend on speeds and travel times, it can be expected that they both point into the same direction. Again, this is generally true in the three sites,



but the mutual dependency also means that they suffer from the same uncertainties with regard to differences between FCD and UTC data and their statistical significance. This uncertainty has to be borne in mind when the results of the VOC calculations are being considered.

Again, as for other evaluation results, the data for Chania was most consistent and therefore these results are the most reliable ones; they are shown in Table 5.10. If the VOCs for petrol cars are taken as a rough estimate for the average costs for the mix of vehicles in the network, then VOCs in the East Entrance increase by €6 per day under TUC, and decrease by €150 per day in the City Centre.

Table 5.10 Vehicle Operating Costs Chania

08:00-23:00	Speed [km/h]		Difference [%]				
	TUC	TASS	Speed	VOC			
				Petrol car	Diesel car	Light truck	Bus
East	12.8	12.9	0.78	-0.25	-0.19	-0.21	-0.16
City Centre	10.8	10.5	-2.86	1.02	0.78	0.89	0.69

08:00-23:00	Speed [km/h]		Difference [cent/100km*veh]				
	TUC	TASS	Speed	VOC			
				Petrol car	Diesel car	Light truck	Bus
East	12.8	12.9	na	-4.85	-3.29	-4.53	-12.27
City Centre	10.8	10.5	na	21.23	14.40	19.93	53.59

The results of the calculations for Southampton are shown in Table 5.11. Based again on VOCs for petrol cars as a rough average costs for the network, the total increase in VOCs per 12-hour day under TUC is around €32, if weighted by flow only, and €24 per 12-hour day, if weighted by flow and link length, for the City Centre. For Bitterne, the weighting by link length changes a €16 daily benefit for SCOOT to a €78 benefit for TUC.

Table 5.11 Vehicle Operating Costs Southampton

07:00-19:00	Speed [km/h]		Speeds factored by flow only				
	SCOOT	TUC	Speed	Difference in VOC [cent/100km*veh]			
				Petrol car	Diesel car	Light truck	Bus
Bitterne	33.56	33.33	na	1.46	0.97	1.16	4.17
City Centre	31.56	31.16	na	2.95	1.98	2.43	8.24

07:00-19:00	Speed [km/h]		Speeds factored by flow and length				
	SCOOT	TUC	Speed	Difference in VOC [cent/100km*veh]			
				Petrol car	Diesel car	Light truck	Bus
Bitterne	32.40	33.50	na	-7.22	-4.82	-5.80	-20.53
City Centre	31.30	31.00	na	2.25	1.51	1.86	6.26

For Munich, the VOCs show obviously the same variations between the sets of weeks as the UTC based time savings (Table 5.12). If the VOCs for petrol cars are taken as a rough estimate for the average costs for the mix of vehicles in the network, then VOCs increase by €32 per day under TUC for the four week average, but again it is more appropriate to say that the likely value is somewhere between the €18 per day benefit shown for TUC in weeks 1 and 2, and the €73 per day benefit shown for BALANCE in weeks 3 and 4.



Table 5.12 Vehicle Operating Costs Munich

08:00-19:00	Speed [km/h]		Difference [%]				
	TUC	BALANCE	Speed	VOC			
				Petrol car	Diesel car	Light truck	Bus
Week 1/2	14.5	14.4	-0.69	0.20	0.17	0.20	0.30
Week 3/4	15.8	16.3	3.07	-0.83	-0.69	-0.82	-1.28
All 4 weeks	15.1	15.3	1.31	-0.37	-0.30	-0.36	-0.56

08:00-19:00	Speed [km/h]		Difference [cent/100km*veh]				
	TUC	BALANCE	Speed	VOC			
				Petrol car	Diesel car	Light truck	Bus
Week 1/2	14.5	14.4	na	3.82	2.97	4.08	11.12
Week 3/4	15.8	16.3	na	-15.43	-11.98	-16.42	-45.07
All 4 weeks	15.1	15.3	na	-6.90	-5.35	-7.35	-20.09



6 Conclusions

6.1 Background

TUC was installed in major network parts of Chania, Southampton and Munich and its performance was compared with the three resident systems TASS, SCOOT and BALANCE respectively. TASS had been installed in Chania quite recently, and much effort had gone into optimising and fine-tuning it; therefore TASS in Chania was already a much more challenging competitor to TUC than the fixed-time systems it had been compared against so far in real life and simulation. In Southampton TUC was compared against of SCOOT, the world-wide market leader in real-time signal control, developed more than 20 years ago and, during this time, having undergone a series of amendments and improvements. Moreover, the SCOOT application in Southampton has been extensively fine-tuned over the last 20 years and has to be counted as one of the best-maintained implementations anywhere. In Munich TUC was compared to a brand-new installation of BALANCE, where both systems had equally little opportunity for fine-tuning; in so far this could have been the fairest comparison between two relatively new and sophisticated systems, had it not, unfortunately, been for the lack of data that was admissible for the evaluation.

The TUC implementation and operation was straightforward in all three sites in spite of the fact that they all had very different network and traffic characteristics and very different basic infrastructure. The latter is particularly relevant with regard to the detector types and locations: in Munich, they are typically only 30 m from the stop-line and in Chania in the middle of the link; in Southampton they are near the entrance of the link and, furthermore, in many locations one single loop straddles two lanes.

All main conclusions are drawn from the second demonstration phase since, in any long-term application more time would have been devoted to fine-tuning than had been available, and at that time thought necessary, before the first demonstration phase. With hindsight, it became clear that further improvements could have been achieved for the TUC performance with further fine-tuning. However, there is no indication how significant these additional improvements might have been and, therefore, judgement for the purposes of this report has to be based on the evidence from the second demonstration phase.

6.2 Results

Impact Assessment

The principal aim of the TUC implementations in the three sites was to reduce traffic congestion. Therefore, this is the principal indicator used in the evaluation. Data for this assessment came from two main sources: UTC system data and floating car measurements.

Traffic Flows

From the UTC system, data concerning traffic volumes has been collected for two reasons: first of all, to ensure that comparisons between the performance of the different systems are being made for comparable traffic conditions and, furthermore to find out whether any of the systems would increase the network capacity. If one of the systems had had any significant



impact on the capacity in the controlled network, it would have been expected that there were differences between traffic flows in the surrounding network, in particular in the entry links. However, this was generally not the case, and the only links where substantially larger queues appeared under one system were located in Bitterne, where SCOOT applies deliberate gating at some key entries in order to ensure sufficient capacity within the network. As it turned out, the gating was certainly harsher than necessary because also under TUC, where traffic on these links was allowed to enter the network more or less freely, there was never oversaturation within the network. This meant furthermore that the traffic conditions for which TUC would have been expected to be particularly effective, namely oversaturation within the network where TUC could have potentially prevented blocking back into junctions and subsequent gridlock, never actually occurred in any of the three sites at any time under any of the four control systems.

Average network flows turned out to be in general apparently on a similar level under TUC and the resident systems unless there were obvious reasons for differences, such as special events or severe weather conditions, but in Southampton City Centre flows generally appeared to be between 2% and 5% higher under SCOOT not only in peak periods, but also generally during the whole working day. This could not be explained by changes in capacity nor by rerouting, and other possible causes had to be considered.

It became apparent that the known masking problems associated with the accuracy of the detector data had more impact than anticipated. Masking certainly happened in all three sites and, as a result, the higher the real traffic volume becomes, the higher is the likelihood that the detectors underestimate it. In Southampton masking is aggravated by the fact that many SCOOT detectors straddle two lanes, which means that the detectors may not only fail to identify two cars that follow each other, but will also fail to distinguish between cars that run next to each other in parallel lanes. Moreover, masking does not only concern the directly measured flows, but it also affects occupancy measurements and therefore also speeds. Therefore, the results derived from the detector data must be viewed with some caution.

Occupancy, Tailback and Speeds

The core indicators that were to be used commonly throughout the three sites were traffic speed as a measure of overall performance and occupancy as a measure of congestion. However, the way speeds were measured differed between the sites, dependent on the resident control system, and tailback was therefore an additional indicator used for Munich. Initially, mean speeds for used for every link, but as a final measure, harmonic speeds were derived from this for the overall networks.

Chania

The results derived from loop-detector measurements for the final demonstration phase clearly indicate that TUC outperforms TASS in the City Centre Region. More precisely, TUC outperforms TASS for the intervals 08:00-17:00 and 22:00-23:00 by up to 13% in terms of mean speeds, while TASS is better for the interval 17:00-22:00. The intervals 08:00-09:00, 13:00-15:00 and 22:00-23:00 correspond to peak hours, while the interval 17:00-22:00 correspond to a mix of peak hours and off-peak (it is off-peak for the three of the week days and peak period for the other four days).



It is also worth noting that the mean speeds achieved during the first week, when TUC was running the city centre, are higher than the ones of the two weeks when TASS was running in the same region for almost all the hours of evaluation. During the second week that TUC was running 1 (3rd week of evaluation), the TUC performance was not as good as in the first week, which is possibly due to a different pattern in the traffic demand (due to a local holiday on the Friday of the 3rd week of evaluation). However, such a different pattern is not shown in the detector measurements; the fact that the detector measurements can underestimate traffic flows makes it difficult to provide an explanation in such a case. A similar problem occurs when searching for the reason why TASS is better than TUC in some of the evening hours, where the analysis of the detector measurements does not indicate a difference in the traffic pattern during these hours.

For the East Entrance Region, neither system outperformed the other. However, these results were somehow expected, since the problem with the two junctions of this region is not the implementation of an efficient real-time strategy (for one of the two junctions of this region, junction K12, TASS already employs an efficient technique, specially designed for this junction, that extends the cycle time on a second-by-second basis). It seems that any real-time strategy cannot further improve the traffic conditions in these two junctions, and that a modification in the geometry and the staging of junction K12 is needed. The city council of Chania has already noticed and studied this problem, and is planning to modify the geometry and the staging of junction K12.

Bitterne

The most successful evaluation results for TUC in Southampton were those obtained from data collected during the Bitterne Region during the morning peak. The UTC data was on a par with that collected during SCOOT control, and sometimes better. In general, the detectors that performed better in the a.m. peak under TUC were typically located on the inbound direction of the arterial route at the outskirts of the network, whereas the detectors performing better under SCOOT were on the inbound approach to the City Centre. It should be noted that one of the detectors performing better under TUC was located on a link that was 'gated' during the a.m. peak period under SCOOT control. This gating scheme was instigated with the deliberate aim of holding traffic back at the outskirts of the Bitterne region, thereby artificially controlling the amount of traffic entering the City Centre from the east. The reduction in traffic passing this detector, and improved performance of SCOOT nearer the City Centre, was thereby influenced by the gating scheme, rather than any inherent differences in the SCOOT and TUC algorithms.

By averaging all individual detector values, it was found that, at the same level of flows under both systems, the average ALOTPV across the Bitterne region was approximately equal under SCOOT and TUC, although the speed decreased by about 4% under TUC on average for weekdays with simple flow factoring. Factoring with flow and link length indicates very significant advantages for TUC, although this factoring is regarded as somewhat dubious for Bitterne for reasons explained in chapter 3.2.1.

For the off-peak time interval, speeds measured by the individual detectors under the two systems were evenly balanced, with only small magnitudes in percentage differences. However, ALOTPV was less balanced with more advantages for SCOOT than for TUC.



For the p.m. peak it was found that the number of detectors with significantly different ALOTPV differences was split equally between the two systems. This was also confirmed by the regional average values, which were very similar for both systems. Harmonic speeds, however, were also in the evening again higher under TUC, as they had been for all time periods in Bitterne.

Southampton City Centre

A comparison with the first phase demonstration results showed that the TUC modifications had led to improvements in the City Centre; the detectors that still experienced better traffic conditions under SCOOT were mainly centred along West Quay Road.

Compared with TUC, ALOTPV was reduced by about 25% under SCOOT in the a.m. peak, although this result may have been amplified by the suspected underestimation of TUC flows. In any case, a comparison of these findings with the equivalent results from the first demonstration phase again revealed that the TUC performance had improved and that the modifications made to TUC prior to the second demonstration phase were a step in the right direction.

Although TUC performed better during the p.m. peak compared with the a.m. peak, generally the results still did not quite match those of SCOOT. However, as in the a.m. peak, a comparison with the first phase demonstration results showed that improvements had been made with regard to speeds and ALOTPV. The global results show that the average speeds under SCOOT were about 4% (mean speed) and 1% (harmonic speed) higher than under TUC, while ALOTPV reduced by about 15%.

Both Southampton Regions: Saturdays

Unfortunately the quantity of data collected during the second demonstration phase on Saturdays was very limited. Furthermore, the first two Saturdays had fine weather whereas on the two other Saturdays it was raining. In addition, on one Saturday when TUC was being implemented, the Rugby World Cup Final was televised and clearly resulted in lower flows from 9:00 to 11:30.

However, a detailed analysis of the available data showed that there was very little difference between the performance of TUC and SCOOT in Bitterne and on the two dry Saturdays in the City Centre. Moreover, on the Rugby World Cup day, traffic volumes increased dramatically once the matches were finished, and TUC coped remarkably well with the sudden surge of traffic, keeping traffic speeds and floating car journey time at the same level as on the previous dry weather morning. Moreover, even in the following hour, when TUC had to cope with 530 veh/h the speed still stayed at nearly 27 km/h, while under SCOOT the speed already dropped to the same level of speed at the 26% lower flow of 420 veh/h on the following Saturday.

Munich

In Munich there were significant problems with both the lack of data and the high variability of flows and occupancy measurements, and even more so for model-based tailback and



speed calculations which means that all of the Munich results, but particularly so the latter, need to be viewed with some degree of caution.

From the data that is available for Munich it appears that average flows have been around 2% higher under TUC (3% higher during the peak periods) over all four weeks. The summarised values for occupancy are very similar and, given that flows and occupancy are closely correlated, indicate that both systems performed on more or less the same level. Estimated tailbacks as well as speeds and travel times, which are derived from tailbacks, show a slight advantage for BALANCE for the whole weekday, with a larger advantage during peak hours, but an advantage for TUC during the off-peak.

Travel Times

Chania

The evaluation of the two systems through floating car measurements showed a clearly better performance of TUC compared with TASS, especially during peak hours, in the City Centre. Floating car trips performed when TUC was running had average travel times that were 5%-25% lower than those of TASS during peak hours. Comparisons that are based on floating car measurements are more reliable and accurate than results that are based on detector measurements (as already pointed out). It is also worth noting that in the floating car measurements TUC also outperformed TASS during the evening hours, where analysis based on detector measurements indicated that TASS performed better than TUC.

As for the UTC data, no general conclusions could be drawn about the superiority of the one system over the other in the East Entrance Region, and both systems perform roughly at the same level.

Bitterne

Considering the floating car data, the average weekday a.m. peak journey time on the arterial Bitterne survey route reduced by an impressive 30% under TUC or still 8% after factoring each route section journey time by the flow. This needs to be viewed in the light of the fact that on the route section where the most substantial improvements occurred, gating was used when the signals were controlled by SCOOT to deliberately restrict access. However, the congestion caused by gating this traffic on the outskirts of the network far outweighed the benefits resulting nearer the City Centre, where only one route section fared significantly worse under TUC. Floating car surveys were also undertaken along a second pre-defined route in Bitterne during the second demonstration phase, focusing on the side-roads rather than the main corridor. On this very convoluted route the overall route journey time under TUC increased by about 10% compared to SCOOT, or 15% after factoring by flow. This implied that some of the benefits given to the main corridor were at the expense of the more minor side roads.

The average journey times along the Bitterne arterial route during the off-peak were also very consistent for the SCOOT and TUC systems, but the overall route journey time reduced by about 5% in the TUC scenario. This result was especially impressive when compared with the corresponding finding from the first demonstration phase, which showed a 5%



improvement under SCOOT. This provides more evidence that the TUC modifications over the summer had a positive effect on the Bitterne arterial corridor.

During the pm peak, the journey time along the main corridor route showed under TUC about 5% benefits compared to SCOOT and about 10% after factoring by flow. Again, some of this benefit was 'lost' to SCOOT on the side-road survey route, where the overall route journey time reduced by 9% in SCOOT conditions, although the gap narrowed to 4% after factoring by flow. These results indicate that TUC gave a slightly higher proportion of cycle time to the main road traffic compared to SCOOT, a result commensurate with the a.m. peak findings. However, the benefits to the main arterial route still outweighed the disbenefits experienced in the side road traffic.

Southampton City Centre

For the City Centre, the average weekday a.m. peak journey time on the City Centre survey route increased by about 10% under TUC compared to SCOOT, and during the p.m. peak even by about 20%, which meant that the picture for TUC was worse than shown by UTC speeds for both time periods. This was one exception to the general pattern that had emerged, where TUC fared better in the FCD measurements than when judged by UTC data. There were two main route sections where SCOOT noticeably outperformed TUC: West Quay Road and Archers Road.

Munich

Similarly to the UTC data, also the floating car measurements suffered from the small number of trips that were available for evaluation and the high variability of the data, which meant that only the results for Route 1 are statistically significant at the 90% level. The average figures show 6.3% and 2% less journey time under TUC for Routes 2 and 3, respectively, while for Route 1, which is the main route leading into the city, the a.m. peak journey times are on average 15 % lower for TUC than for BALANCE.

FCD versus UTC data

As was mentioned above, a general pattern emerged whereby the results for TUC were better on the basis of the floating car measurements than when judged by UTC data. No obvious reason was found for this phenomenon, and only some speculative thoughts can be offered:

- One possibility is that there is an inherent bias in the UTC measurements, which have been implemented for the benefit of the resident systems rather than for TUC.
- Another possibility is that there is a bias in the routes selected for the floating car measurements. Certainly the very different results for the two Bitterne routes demonstrate how important the route choice is for the overall result. It could have been pure coincidence that TUC fared particularly well on the FCD routes.
- A third possibility is related to the choice of FCD routes. The main routes for all sites have been designed to signify the most relevant directions that cars would take in these networks; only the Bitterne side route was chosen to assess delays encountered by traffic crossing or turning into the main arterial. It is conceivable that TUC generally favours



the main routes in the network to the expensive of minor links and side roads. If this were true, then it would be a finding relevant for future applications.

As stated before, unfortunately, this is all speculation, and there was no opportunity within the SMART NETS project to investigate this further. Such an investigation could be a worthwhile subject for a small research project or MSc dissertation.

Fuel Consumption and Emissions

Increases or decreases in fuel consumption were following the same direction as emissions in all sites and for all time periods. With the one exception of the Southampton Saturday data (where both indicators were much lower under TUC), differences between the UTC systems were very small, generally under 3%.

Furthermore, both indicators were roughly in line with the findings for mean and harmonic speeds, as could be reasonably expected, given that speeds are the variable used for calculating them. Remarkably, there was one exception: in Southampton City Centre, fuel consumption and emissions were lower for TUC, although the mean speeds were higher. Harmonic speeds had not been calculated for Southampton in the initial evaluation, and the main reason why they were still introduced at the last minute was that it was expected that they would then explain the reduction in fuel consumption, but that did not turn out to be the case. One other potential explanation that was investigated was that the variation between speeds on different links was different between SCOOT and TUC, which could have explained the results, since the relationship between speeds and fuel and emissions is non-linear; however, it was found that the standard deviation for speeds was very similar for both systems.

Impact on Public Transport

Although a module for public transport prioritisation was especially developed for TUC in the SMART NETS project, public transport travel times were not a primary consideration in the evaluation process. In the case of Chania they were not investigated separately, since there are no bus priority measures in place and buses would benefit from reduced congestion in the same way as cars. In Munich, neither TUC nor BALANCE influence public transport, since buses and trams are given priority here by local controllers that are allowed to override control decision made by the central system. Neither BALANCE nor TUC were in any way an impediment to this, and therefore neither control system led to any increases in PT travel times in Munich. In Southampton, bus travel times had been observed during the verification phase, and it was concluded that TUC's bus priority was generally working appropriately.

User Acceptance and System Costs

The user acceptance of TUC has been assessed by analysing the responses provided to the User Acceptance Questionnaire by the system operators in each site. The questionnaire includes questions on the effort and costs required to implement TUC or a comparable UTC system, as well as the costs of ongoing operation and maintenance. Responses focused on



whether implementation and maintenance of TUC was more or less onerous than for the base UTC system.

Overall, user acceptance of TUC was very high, and especially so in Chania. The operators reported that TUC is an excellent strategy that, with careful fine-tuning, can show a very efficient performance.

According to the responses to the User Acceptance Questionnaire, the implementation of TUC was very straightforward in all sites, but again this was felt particularly in Chania, when compared with the effort required for a TASS implementation. The main effort involved for implementing TUC in all sites was the development of the new interface between TUC and the existing systems. The one additional data requirement for TUC was the need for estimates of turning movements, and the Southampton operators did carry out special surveys to get them right, which incurred additional costs. Requirements for local controllers are lower than for TASS and the same as for BALANCE and SCOOT, while, with current computer technology, there are no differences in necessary costs for any of the four systems. Requirements for data transmission are approximately equal for TUC, TASS and BALANCE, while SCOOT requires second-by-second data interchange, which can significantly increase transmission costs, depending on the communication infrastructure.

The most significant disadvantage for TUC was the current lack of a good user interface, which was strongly missed by the Southampton operators. It is clear that for the future commercial exploitation of TUC such an interface will need to be built.

The costs involved in operating TUC are very much the same as for the other systems, except for the above-mentioned potential cost difference for data transmission. System maintenance costs for TUC are expected to be the same as for BALANCE, somewhat higher than for SCOOT, since the Southampton believe it easier to make adjustments to SCOOT, and lower than for TASS due to a lesser need for parameter updates.

Overall, all operators felt that TUC had performed remarkably well compared with much more established system, even if not all hopes concerning its potential to reduce congestion could be fulfilled. Both SCC and KVR would have supported further TUC implementations their cities if the impact assessment had provided clear evidence that TUC could improve significantly on SCOOT and BALANCE. In the current circumstances, SCC and KVR will watch any further development of TUC and results of future TUC implementations, in order to decide whether TUC should be installed in other parts of their cities at a later stage. In contrast to SCC and KVR, the Chania operators were already convinced by TUC's current performance, and they have every intention to use and exploit TUC beyond the lifetime of SMART NETS.

Socio-Economic Benefits

The highest benefits were generally calculated from time savings based on floating car data, but some of the UTC data also leads, when summed up over the whole year, to very high benefits.

The best overall result was achieved for the Chania City Centre, where even the more conservative estimate based on UTC data leads to time savings worth a staggering €0.6m



per year. It seems therefore safe to say that the annual total benefits from TUC in Chania will far outweigh any possible investment, operation and maintenance costs in a UTC system in a short time period, even if TUC had been implemented from scratch and not been introduced as an alternative to the existing TASS system.

For Southampton the results are less conclusive and vary largely depending on the data used for the benefit calculation. For the City Centre, floating car data is only available for peak hours, but the total time savings under SCOOT for four peak hours based on this data add up to €1.1m per year, if taken as measured, or a still a very substantial €0.7m, if the journey times are factored by flow. UTC based harmonic speeds, which are available for the whole day and are therefore in this case much more representative than FCD based results, lead to a lower, but still significant figure of €0.09m per year.

For Bitterne, there are also time savings under SCOOT for the Side Roads Route, which amount to €0.8m per year as measured, and €0.3m, if factored by flow; but this again is data for peak hours only. All other data in Bitterne shows major advantages for TUC. The peak hour only data for the Bitterne Main Route indicates savings of €1.0, respectively €0.3m if factored, which in both cases would outweigh the anyhow less representative results for the Side Route. If the off-peak measurements are included as well, the benefits for the 12-hour day amount to €1.4, respectively €0.7m per year. And even the more conservative figures based on harmonic speeds from the UTC system still lead to a net benefit of €0.3m per year for TUC.

In Munich, the FCD data would indicate an annual benefit through time savings for the morning peak alone of up to €0.3m under TUC, while the UTC data would indicate savings of anywhere between €0.08m under TUC and €0.2m under BALANCE for the whole 11-hour day per year, depending on the demonstration weeks used for the calculations.

Savings from Vehicle Operating Costs are, as is completely normal, only in the range of 10% of the benefits from time savings for all demonstration sites.

Overall

TUC performance in all of the test sites demonstrated that it is a valid and credible UTC strategy, both as a stand-alone system as in Chania and Southampton, and as a hybrid. Since two very different versions of such hybrids have been implemented within SMART NETS, one in conjunction with BALANCE in Munich and one during the first demonstration phase with SCOOT in Southampton, it appears credible that combinations with any other UTC system would be possible as well.

Although the demonstrations did not show the same level of improvements as had been achieved by TUC in simulations compared with simple fixed-time control, TUC stood up very well against the well-established and sophisticated resident systems in the three cities.

The improvement in the results from the first to the second demonstration phase in Southampton and Chania showed that, initially, the potential for optimising TUC's performance through fine-tuning had been underestimated, and it has become apparent that its performance could still have been improved, mainly by further tuning of weights and importance factors given to individual links. In Southampton, further improvements would



probably have been possible by splitting the two large control areas into sub-areas and allowing different cycle times to be applied between them, as is currently done by SCOOT and has also been proven successful for TUC in the Chania application.

Problems with detectors have been encountered in all three sites and, moreover, problems with the basic control and communication infrastructure have persisted in Munich throughout the demonstration. The results of all the demonstrations have shown convincingly that TUC is a very robust system that could provide satisfactory signal control even under these adverse conditions.

One further very important finding from the demonstrations is that TUC can perform well in any type of network: the five test areas in the three cities have very different characteristics both with regard to network layout and with regard to traffic behaviour. This allows the conclusion that TUC can be successfully implemented in any other site in Europe or elsewhere in the future.

Overall, the SMART NETS project has demonstrated that TUC has the potential to become a strong competitor in the worldwide UTC systems market.

6.3 Lessons Learnt from the SMART NETS Demonstrations

The demonstrations started in all three sites with only a minimum of fine-tuning, and this was proof for one of the most important SMART NETS promises: that even with hardly any fine-tuning at all and without the incorporation of the additional features introduced later, TUC achieved a very efficient and acceptable performance during these first weeks

However, the potential for further improvements through more fine-tuning had initially been underestimated. Problems and phenomena that had not been foreseen – and could not have been foreseen before the implementation of TUC in the field – made it necessary to re-visit TUC and to employ additional features that could improve its performance. The development of these features had to take into account phenomena and problems that may occur in any traffic network as well as others that are specific to one site, such as the double/illegal parking in Chania.

Two main extra features added to TUC were smoothing and filtering elements and extra ‘play-buttons’. The addition of smoothing and filtering elements had the effect of filtering out measurements and control decisions that were unrealistic or corresponded to phenomena where the estimation of traffic conditions were erroneous (e.g., vehicles parked on the detector). The addition of extra ‘play-buttons’ provided the operator with design parameters that could alter and affect TUC’s performance significantly. The important fact with these extra ‘play-buttons’ is that they provide the operator with a ‘recipe’ on how to improve TUC’s performance, that is, by inspecting the measurement data and TUC’s decisions it is relatively straightforward to decide which of these ‘play-buttons’ should be modified and in which way. The addition of these two features quickly led to a significant improvement of TUC during the first demonstration phase in Chania, and the smoothing and filtering elements were then used in the other test sites as well.

Another very significant set of modifications was the introduction of the two regions as well as the introduction of double cycling in junctions where double/illegal parking takes place.



The introduction of these two modifications had a very positive effect on TUC's performance in Chania, and will also be a permanent feature in future TUC implementations.

The most important feature developed initially only for Southampton, in response to some problems encountered in some links in Southampton City Centre, was the inclusion of weights and importance factors that allowed TUC to prioritise free traffic flows in some critical links. Again this has now become a general feature in the TUC system.

6.4 Recommendations for Future TUC Implementation

The first recommendation relates to the existing TUC implementation in Munich since the detailed analysis of the available data for the impact assessment was, unfortunately, inconclusive, with large variations between the two sets of week-by-week comparisons. Since both BALANCE and the BALANCE/TUC hybrid are now available for the Haidhausen area, and both appear to provide overall a good level of control, it would be desirable to let them operate in turn over the coming months and to observe whether any firmer conclusions on their relative performance can be drawn in the future.

The most important recommendation with a view to new implementations is the need to develop a user-friendly interface. The best way forward towards this end would be a co-operation between TUCrete and a UTC system manufacturer, who does not yet have a license for other advanced UTC systems and would therefore see the inclusion of TUC in their product palette as a market opportunity.

The conclusion of the SMART NETS project will not end the effort to inform urban control operators about the potential of TUC as a cost-effective answer to urban traffic and congestion problems. Dissemination and marketing activities will continue in the foreseeable future. Operators will be encouraged to introduce TUC in any part of their cities, and TUCrete will support any implementation anywhere in the world.

In the simulations carried out before SMART NETS started, the most significant improvements could be achieved by TUC through preventing gridlock. Such gridlock did not occur in any of the SMART NETS sites during the demonstration under either TUC or the resident system. Therefore, TUCrete would be particularly interested in implementing TUC in sites where gridlock is a frequent problem at the current time, in order to confirm that TUC can reach its fullest potential under such difficult circumstances.



7 References

Condie, H., Bielefeldt, C., Diakaki, C., Mueck, J. and Richards, A (2002) Final Evaluation Plan, **SMART NETS Deliverable D13** (Internal document).

Diakaki, C., Dinopoulou, V., Aboudoulas, K. and Papageorgiou, M. (2002) Final System Development Report, **SMART NETS Deliverable D9** (public deliverable, available at www.smart-nets.napier.ac.uk).

EWS, Empfehlungen für Wirtschaftlichkeitsuntersuchungen an Straßen, Forschungsgesellschaft für Straßen- und Verkehrswesen, Köln 1997

Kosmatopoulos, E., Bielefeldt, C. and Condie, H. (2004) Evaluation Results Chania, **SMART NETS Deliverable D18** (public deliverable, available at www.smart-nets.napier.ac.uk).

McLean, T., Brader, C., Hangleiter, S., Tsavachidis, M, Damas, C., Maxwell, B. and Barber, P. (1998), Urban Integrated Traffic Control Evaluation Results, **TABASCO Deliverable D8.3**, Brussels, July 1998.

Marinakis, G., Kosmatopoulos, E., and Dinopoulou, V. (2004) Demonstration Report Chania, **SMART NETS Deliverable D15** (Internal document).

Mueck, J., Hanitzsch, A. (2004) Demonstration Report Munich, **SMART NETS Deliverable D17** (internal document).

Mueck, J., Hanitzsch, A., Condie, H. and Bielefeldt, C. (2004) Evaluation Results Munich, **SMART NETS Deliverable D20** (public deliverable, available at www.smart-nets.napier.ac.uk).

Richards, A., Morris, R., Green, M. and Condie, H (2003) Demonstration Report Southampton, **SMART NETS Deliverable D16** (Internal document).

Richards, A., Bielefeldt, C., Condie, H. and McDonald, M. (2004) Evaluation Results Southampton, **SMART NETS Deliverable D19** (public deliverable, available at www.smart-nets.napier.ac.uk).

Thurlbourn, C., Kalogiannis, G., Marinakis, G., Kosmatopoulos, E., Dinopoulou, V. and Condie, H (2003), Verification Report, **SMART NETS Deliverable D14** (Internal document).